

**RESTRICTED**

**- 1 -**

**VK2DYM**

**ROYAL AUSTRALIAN ARMoured CORPS**

**TRAINING**

**NOTES FOR ROYAL AUSTRALIAN ARMoured**

**CORPS RADIO INSTRUCTORS**

**RAAC CONTROL HARNESSSES AND**

**THEIR OPERATING PROCEDURES**

**RESTRICTED**

RESTRICTED

- 2 -

ROYAL AUSTRALIAN ARMOURD CORPS TRAINING

NOTES FOR RAAC RADIO INSTRUCTORS, 1972

PREFACE

1. The aim of this precis is to provide a basic reference for RAAC Radio Instructors.
2. It contains the necessary information for instructors to teach crewmen the general details and operation of the Control Harnesses in current use in the RAAC.
3. Apart from the laid down TESTS, no attempt has been made to list the corrective measures for ALL possible harness faults. By having a thorough working knowledge of the equipment, and a common sense approach, the user should be able to isolate the majority of faults and take remedial action.
4. The configurations of the Control Harnesses will depend on the type and role of the vehicles in which they are fitted. Because of the many variations and continual change of these configurations, this Precis only deals with the Control Harnesses in their basic form.
5. Information on the general details and operation of radio configurations, and radio ~~and antenna~~ theory has been included in two further Precises. These Precises are:-
  - a. RADIO CONFIGURATIONS AND THEIR OPERATING PROCEDURES.
  - b. BASIC ELECTRICITY, RADIO AND ANTENNA THEORY.
6. These three Precises, together with the Pamphlet No. 7 - RADIO TELEPHONE PROCEDURE, will provide a comprehensive coverage of the theoretical and technical knowledge required by a Radio Instructor in the RAAC.

RESTRICTED

RESTRICTED

- 3 -

ROYAL AUSTRALIAN ARMoured CORPS TRAINING

NOTES FOR ROYAL AUSTRALIAN ARMoured CORPS

RADIO INSTRUCTORS

RAAC CONTROL HARNESS AND THEIR

OPERATING PROCEDURES

1972

	<u>PAGE</u>
Title Page	1
Preface	2
Contents	3 -

<u>CHAPTER</u>		<u>PAGE NO.</u>	<u>PARA</u>
1	<u>CONTROL HARNESS B1</u>		
	General	1 - 1	1
	Facilities	1 - 1	2
	Power Supply	1 - 1	3
	Construction	1 - 2	4
	Junction Box, One-set J1	1 - 2	5 - 6
	Control Unit, Drivers D	1 - 5	7 - 8
	Control Unit, Operators C	1 - 6	9 - 10
	Adapter Unit T	1 - 7	11
	No. 6 Microphone	1 - 8	13
	No. 7 Microphone	1 - 9	14
	Remote Handset No. 1	1 - 10	15 - 18
	Connector 12 pin, No. 88	1 - 11	19
	Connector 6 pin, No. 35	1 - 11	20
	Voltage Control Relay	1 - 11	22 - 26
	Opening Up Drills	1 - 16	27
	Tests	1 - 16	28
	Operation	1 - 19	29
	Closing Down Drill	1 - 20	30
	<u>CONTROL HARNESS B2</u>		
	General	2 - 1	31
	Facilities	2 - 1	32
	Power Supply	2 - 1	33
	Construction	2 - 2	35
	Junction Box J2	2 - 3	36 - 37
	Remote Control Unit, R	2 - 4	38 - 39
	Rebroadcast Unit, B	2 - 6	40
	Control Unit, Operators C	2 - 8	41 - 42
	Control Unit, Drivers D	2 - 9	43 - 44
	Adapter Unit, T	2 - 9	45

RESTRICTED

RESTRICTED

- 4 -

<u>CHAPTER</u>		<u>PAGE NO.</u>	<u>PARA</u>
	No. 6 Microphone	2 - 10	47
	No. 7 Microphone	2 - 11	48
	No. 4 Microphone	2 - 12	49
	Remote Handset	2 - 13	50
	Opening Up Drills	2 - 14	53
	Tests	2 - 14	54
	Closing Down Drills	2 - 19	55
3	<u>CONTROL HARNESS TYPE "A"</u>		
	General	3 - 1	56
	Harness Types	3 - 1	57
	Facilities	3 - 1	58
	Radios used in Harness	3 - 2	59
	Power Supply	3 - 2	60
	Construction	3 - 3	61
	Junction Dist No. 9	3 - 4	62 - 63
	Control Unit No. 31	3 - 6	64
	Junction Dist No. 8	3 - 7	65
	Control Unit No. 34	3 - 8	66
	No. 5 Microphone	3 - 9	67
	Control Unit No. 30	3 - 12	68 - 69
	Remote Handset	3 - 13	70
	Remote Cable Drum	3 - 16	71
	Inf/Tk Telephone	3 - 16	72
	Emerg. Crew Control	3 - 18	73
	Fuses	3 - 18	74
	No. 6 Microphone	3 - 21	75
	Connectors No. 35 and 88	3 - 21	76
	Operation of Remote	3 - 21	77
	Operation of Inf/Tk	3 - 22	78
	Operation of Emerg IC	3 - 22	79
	Auto Rebroadcast	3 - 23	80
	Manual Rebroadcast	3 - 23	81
	Operation of CU 34 and No. 5	3 - 24	82
	Fire Alarm Circuit	3 - 27	83
	Opening Up Drills	3 - 27	84
	Tests	3 - 28	85
	Closing Down Drills	3 - 33	86
4	<u>AN/VIC 1 (V) CONTROL HARNESS</u>		
	General	4 - 1	87
	Configurations	4 - 1	88
	Components	4 - 1	89
	Power Supply	4 - 2	90
	Component Construction	4 - 2	91
	AM/1780	4 - 2	92
	AK/1780 Connectors	4 - 3	93
	AK/1780 Controls and Switches	4 - 3	94
	G2298	4 - 5	95

RESTRICTED

- 5 -

<u>CHAPTER</u>	<u>PAGE NO</u>	<u>PARA</u>
C-2298 Connectors	4 - 6	96
C-2298 Switch and Control	4 - 6	97
C-2296	4 - 7	98
C-2296 Connectors	4 - 7	99
C-2296 Switch and Control	4 - 8	100
C-2297	4 - 9	101
C-2297 Connectors	4 - 9	102
C-2297 Switches and Controls	4 - 9	103
C-2299	4 - 10	104
C-2299 Connectors	4 - 10	105
C-2299 Switches and Control	4 - 11	106
H-161A/U or H161/GR	4 - 11	107
Helmet T56-6	4 - 14	108
Helmet Switch Assembly	4 - 14	109
Operation IC Only	4 - 14	110
Operation AM/1780 Radios Fitted	4 - 15	111
Operation C-2296	4 - 15	112
Operation C-2297	4 - 17	113
Operation C-2298	4 - 18	114
Operation C-2299	4 - 19	115
Opening Up Drills	4 - 19	116
Tests	4 - 20	117
Closing Down Drills	4 - 25	118

RESTRICTED

RESTRICTED

1 - 1

CHAPTER 1 - CONTROL HARNESS B1

General

1. The Control Harness B1 is designed to be used with the British radio sets RS C42, RS B47 and RS C13. While the harness is intended primarily for use in vehicles, it can quite easily be used as a Ground Station. It provides a means of controlling one radio set from various positions in a vehicle or other positions i.e., within buildings or when used as a Ground Station. It can also control inter-communications in conjunction with an Audio Amplifier incorporated in the radio set being used i.e., an RS C42 or RS C13 (the RS B47 does not have an Audio Amplifier). In the RAAC, the Control Harness B1 is used mainly in light, wheeled vehicles.

Facilities

2. The facilities provided by the Control Harness B1 are as follows:-

- a. Control of One Set. Either an RS C42, RS C13 or RS B47.
- b. Inter-communication (IC). Enables crew members to speak to each other without transmitting over the radio set.
- c. Call System. Enables the crew members to attract each others attention and indicate that they wish to speak on the inter-communication system.
- d. Remote Automatic Rebroadcast. A means of retransmitting a signal received on one frequency via a transmitter on a different frequency. Can only take place between two VHF (Very High Frequency) sets with similar squelch circuits. Because there is only one set in the B1 Harness, a second B1 Harness has to be connected remotely by wire to enable Remote Automatic Rebroadcast to take place.
- e. Remote Control. Enables the facilities of the harness to be controlled remotely via a handset that is connected to the harness by wire. The maximum length of the wire that can be used is 1000 metres.
- f. Voltage Control Relay. Controls the input voltage to the radio set. Should the voltage to the set vary, the VCR will adjust the input to ensure that the set receives the correct operating voltage. (See Chapter 1, Para 22 for the detailed operation of the Voltage Control Relay).

Power Supply

3. The voltage required to operate the harness is 24 volts d.c. (direct current). The harness is powered by a separate power input and not from the radio set. Power can be derived from either a vehicle generating system, radio batteries or mains rectifier. Power consumption is approximately  $\frac{1}{2}$  ampere.

RESTRICTED

1 - 2/. Each

RESTRICTED

1 - 2

Individual Component Construction

4. Each control unit and junction box is of similar cast aluminium construction, although the sizes and shapes vary according to the function of the unit. Each box is hermetically sealed to render it moisture and dust proof, and is mounted on a flexible base by means of which it is secured in a convenient position in the vehicle. Each control unit and junction box is clearly marked with the designation by which it is identified. All plugs and sockets are protected by screw on plastic covers when the connections are not in use. All switches and controls are fitted to the face of the boxes and are protected by a raised flange.

JUNCTION BOX, ONE - SET "J1"

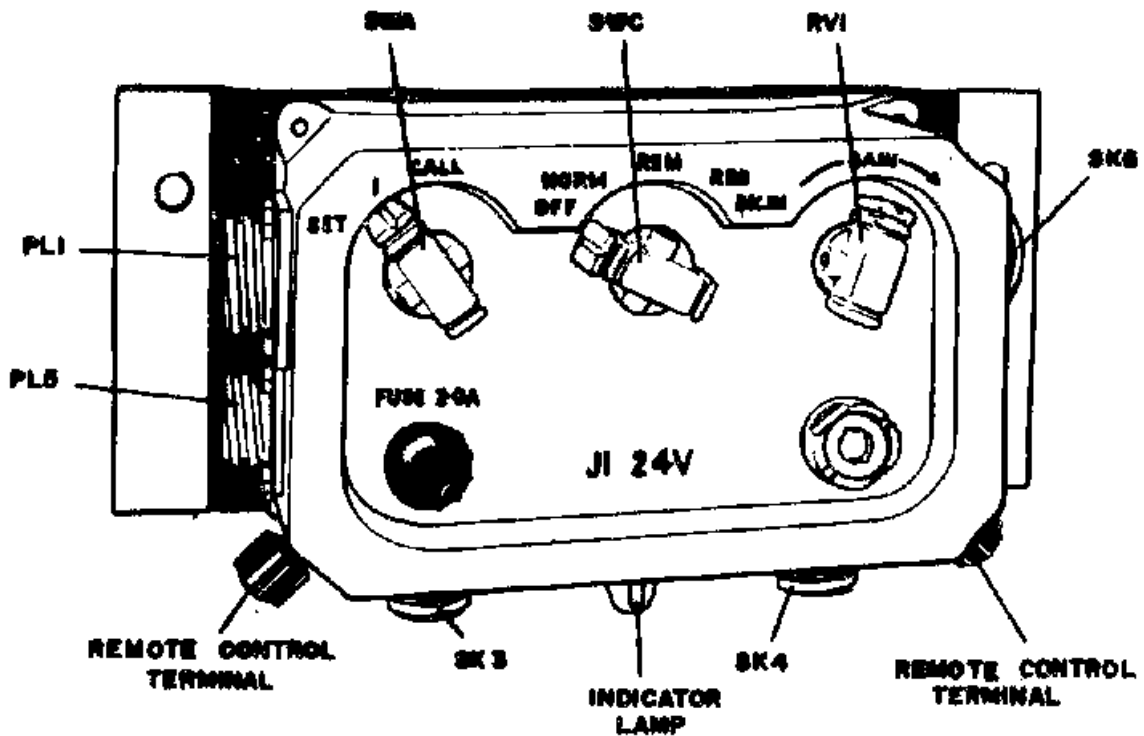

Figure 1

Junction Box, One-Set "J1"

5. This junction box is used to connect one radio set to the control harness. It is the main component in the harness and can provide all the control facilities on it's own without the use of additional control units or junction boxes. It is provided with a 12 pin plug PL1 for connection to the radio set, a 12 way socket SK6 for connection to an operator's or driver's control unit or a commander's microphone. A 2 pin plug PL5 is fitted for the LT (low tension) power input supply and two 6 pin sockets are located on the bottom of the J1 to enable crewman's microphones or "T" boxes to be connected, (SK3 and SK4). Two screw in remote terminals are provided to enable the remote cable to be connected. The left-hand terminal is marked negative (-) and the right-hand terminal positive (+) as the polarity of the remote cable is important when using Remote Automatic Rebroadcast. The Voltage Control Relay is incorporated in the J1.

RESTRICTED

1 - 3/. The switches

"J1" Switches and Controls

6. The switches and controls on the Junction Box J1 are as follows:-

- a. Left-hand Switch. The 3 positions on this switch are as follows:-
- (1) SET. Enables the user to transmit and receive over the radio set.
  - (2) "I". Enables the user to communicate with other members on the inter-communications system.
  - (3) CALL. In this position the switch is spring loaded, and will return to "I" unless held at CALL. When held at CALL it causes a buzzer to send a calling signal over the intercom circuit. All members connected to the harness will hear the buzzer regardless of what they are switched to.

Note:

The B1 harness does not have a monitor facility, therefore you cannot for example, select "I" and hear the incoming signals on the radio set.

- b. Centre Switch. The 5 positions of this switch are as follows:-
- (1) OFF. In this position the voltage control circuit the IC buzzing relay, the red indicator lamp and the remote control terminals are switched off and disconnected.
  - (2) NORMAL. VCR, buzzer relay and the red indicator lamp are switched on and the remote control terminals are still disconnected.
  - (3) REMOTE. All "NORMAL" switch position facilities are retained plus the remote control terminals are connected and the remote handset can be used.
  - (4) RRB. Used when Remote Automatic Rebroadcast is required between two one set installations. Operators connected to the J1 can listen to the remote rebroadcast signals. If an operator were to transmit in this position he would only transmit over his own set and interfere with the rebroadcast system.
  - (5) BK. IN. (break-in). Enables the operator to transmit over the rebroadcast system. If left in this position accidentally, the rebroadcast system would be severed.
- c. Right-hand Control. This is a gain control which increases or decreases the volume level in the earphones of all microphones connected to the J1. It is rotated clockwise to increase the volume.



RESTRICTED

1 - 4

- d. Dessicator. To absorb any moisture in the J1. Fitted with a glass guage to indicate the level of absorption. When the central indicator has turned from a white colour to pink, the dessicator has reached maximum absorption and must be brought to the attention of the radio mechanics for repair.
- e. Fuse. A 2 ampere, short cartridge fuse is located beneath a screw on plastic cap. The symptoms of a blown 2 ampere fuse are as follows:-
- (1) LT indicator lamp goes out.
  - (2) No call buzzer.
  - (3) VCR selects Low Tap.
  - (4) No transmit on the remote handset (over the radio).
  - (5) No transmit on REB.

Note:

The harness must be switched OFF before the fuse is replaced to avoid the chance of blowing the fuse during replacement.

- f. LT Indicator Lamp. When illuminated, indicates that low tension power is connected to the J1. Fitted with a rotating dimmer shield for blackout purposes. A 28 volt, 0.04 Ampere Pea bulb is used for illumination, and the cover can be quickly removed for replacement.

CONTROL UNIT, DRIVER'S "D"

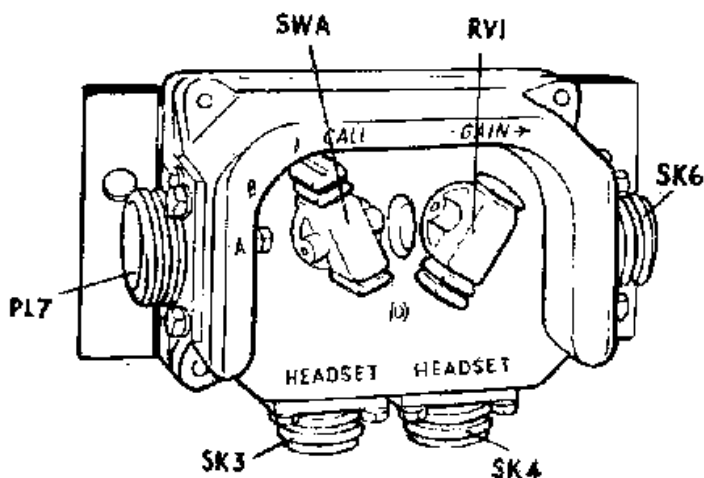

Figure 2

RESTRICTED

1 - 5/. This unit

RESTRICTED

1 - 5

Control Unit, Driver's "D"

7. This unit is provided for driver and co-driver's use. A 12 pin plug PL7, on the left-hand side is used to connect it to the J1 via a 12 pin cable. A second 12 pin plug SK6 enables either a "C", "D" box or commander's microphone to be connected. On the bottom of the "D" box, two six pin plugs are provided for the connection of crewman's microphones or "T" boxes, or 9.14 metre (30 foot) audio extension cables (6 pin).

"D" Box Switches

8. The "D" Box is fitted with one switch and one control. They are as follows:-

- a. Left-hand Switch. This switch has four positions and they are as follows:-
  - (1) "A". Enables the operator to receive on the "A" set. (normally the main set in the installation). This position is not used when the "D" box is used in the B1 harness. The IC can also be heard in this position.
  - (2) "B". Enables the operator to receive on the "B" set and also receive on the IC.
  - (3) "I". Enables the operator to communicate on the intercommunication system.
  - (4) CALL. In this position the switch is spring loaded, and will return to "I" unless held at call. When held at CALL it causes a buzzer to send a calling signal over the intercom circuit. All members connected to the harness will hear the buzzer regardless of which position they are switched to.
- b. Right-hand Control. This is a gain control which increases or decreases the volume level in the earphones. It is rotated clockwise to increase the level of the volume.

Note:

If a "C" Box is connected to a "D" Box, it will not lose any of its original facilities.

1 - 6/. This unit

RESTRICTED

RESTRICTED

1 -6

CONTROL UNIT, OPERATOR'S "C"

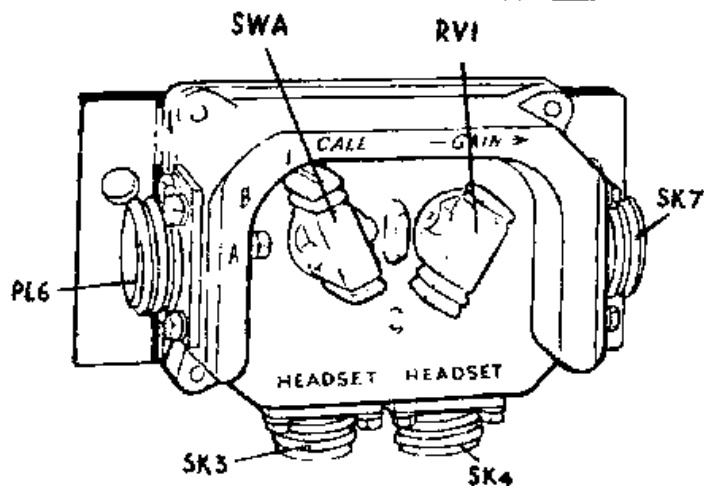

Figure 3

Control Unit, Operator's "C"

9. This unit is provided for the Operator. Apart from the designating letter "C", it is externally identical to the Control Unit, Driver's "D". Refer to Chapter 1, para 7 for a description of the plugs and connectors.

"C" Box Switches

10. The "C" Box is fitted with one switch and one control. They are as follows:-

- a. Left-hand Switch. This switch has four positions and they are as follows:-
  - (1) "A". Enables the operator to transmit and receive on the "A" set.
  - (2) "B". Enables the operator to transmit and receive on the "B" set.
  - (3) "I". Enables the operator to communicate on the intercom system.
  - (4) CALL. In this position the switch is spring loaded, and will return to "I" unless held at CALL. When held at CALL it causes a buzzer to send a calling signal over the intercom circuit. All members connected to the harness will hear the buzzer regardless of which position they are switched to.
- b. Right-hand Control. This is a gain control which increases or decreases the volume level in the ear-phones. It is rotated clockwise to increase the level of the volume.

1 - 7/. The volume

RESTRICTED

RESTRICTED

1 - 7

Note:

The volume controls on all control units mentioned so far will not effect the level of the volume in the earphones of a commander's microphone as it has its own volume control.

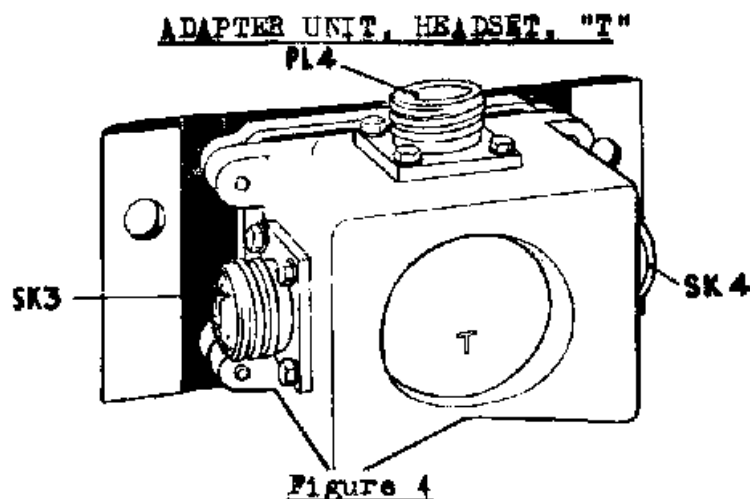

Adapter Unit, Headset, "T"

11. This unit is used to provide connections for additional crewmen's microphones. (Refer to Figure 4). The "T" Box is not fitted with any controls and is controlled by whichever Control Unit it is connected to. It has three six pin connectors, these are:-

- a. PL4. To connect either a J1, "D" Box or "C" Box via a 6 pin cable.
- b. SK3. To connect a crewman's microphone.
- c. SK4. To connect a crewman's microphone.

Note:

Further "T" Boxes can be connected to sockets SK3 and SK4 if required. The "T" Box will have the same facilities as the control unit that it is connected to. It must be connected to a 6 pin crewman's microphone socket.

Audio Equipment

12. The audio equipment that can be used with the B1 Control Harness is as follows:-

1 - 8/. This is

RESTRICTED

RESTRICTED

1 - 8

CREWMAN'S MICROPHONE HAND SI NO. 6

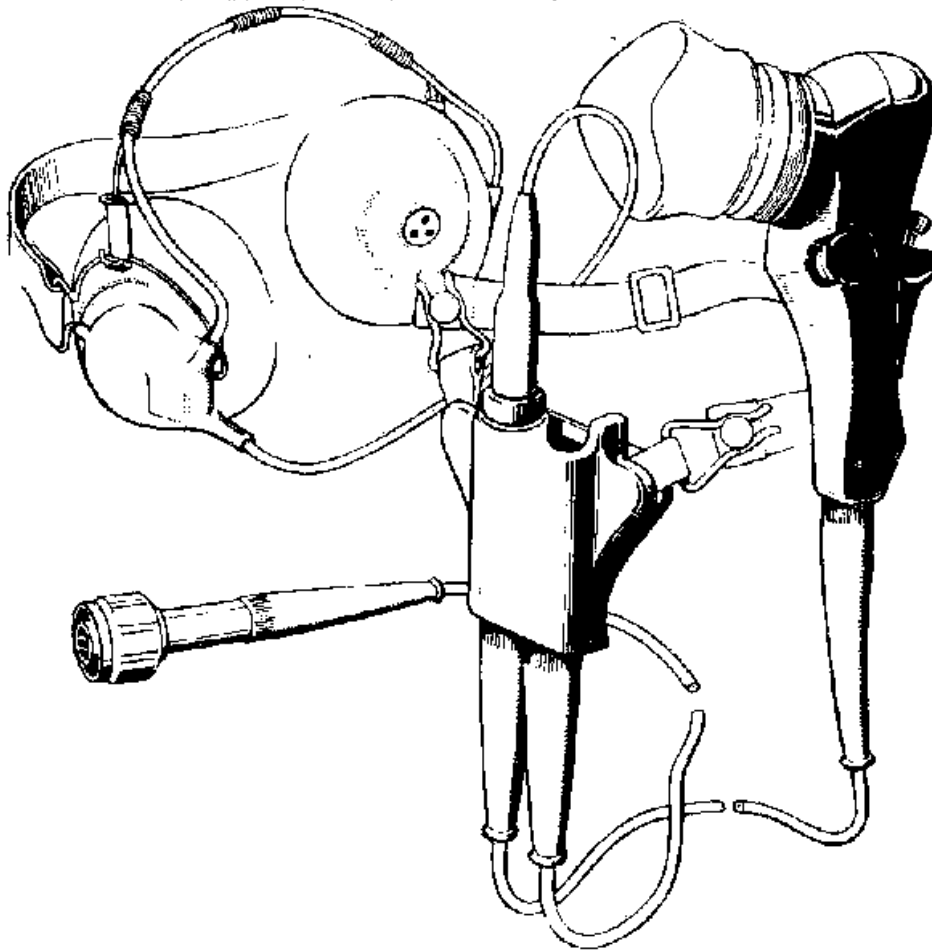

Figure 5

Crewman's Microphone Hand SI No. 6

13. This is the microphone and receiver headgear assembly used by all personnel except the commander. It is designated Microphone hand SI (standard insert) No. 6 and neckband snatch harness, and Receivers headgear SI double No. 1A. The electrical connectors from the microphone and receivers are joined at a small junction box (breastplate) which normally hangs from the user's neck on a web strap. A snatch plug connects the receiver phones to the junction box, which is itself attached to the neckband harness by means of stud fasteners. Snatch plug and stud fasteners will easily part if given a sharp pull, and thus in an emergency the wearer can quickly free himself from the assembly. A press to talk switch on the microphone performs send-receive switching, this switch being readily manipulated by either hand. The audio lead is fitted with a 6 pin plug. A

1 - 9/. two pin

RESTRICTED

RESTRICTED

1 - 9

two pin socket is located on the side of the microphone body to enable a respirator fitted with a microphone element to be connected. The receiver headgear is adjustable to suit the size and shape of the user's head. (See Figure 5).

COMMANDER'S MICROPHONE HAND SI NO. 7

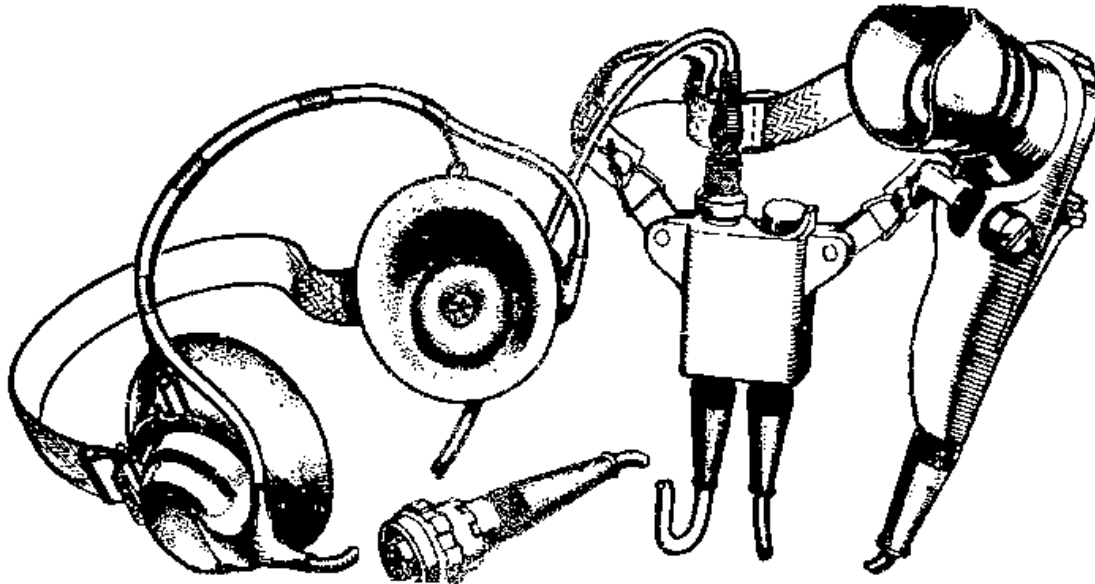

Figure 5

Commander's Microphone Hand SI No. 7

14. This microphone is similar in construction to the No. 6 microphone. It has a 12 pin plug on the audio lead and a volume control on the top of the junction box (breast plate). This control is rotated to increase or decrease the level of the volume in the earphones. A toggle switch is located directly beneath the microphone mouth piece and has the following positions:-

- a. CALL. A spring loaded position to operate the call buzzer.
- b. "I". Enables the commander to communicate on the intercommunication circuit.
- c. "B". Enables the commander to transmit and receive on the "B" set. Must be in this position when transmitting and receiving on the one set in the B1 Control Harness.
- d. "A". Enables the commander to transmit and receive on the "A" set. Not used when connected to the B1 Control Harness.

Note:

- a. This microphone does not have a monitor facility.

RESTRICTED

1 - 10

- b. The No. 4 commander's microphone is almost identical to the No. 7. The only difference being that the No. 4 does not have a 2 pin respirator socket on the side of the microphone body.
- c. The No. 4 or No. 7 can be connected to either a J1, "C" Box or "D" Box.

TELEPHONE, HAND, REMOTE CONTROL NO. 1

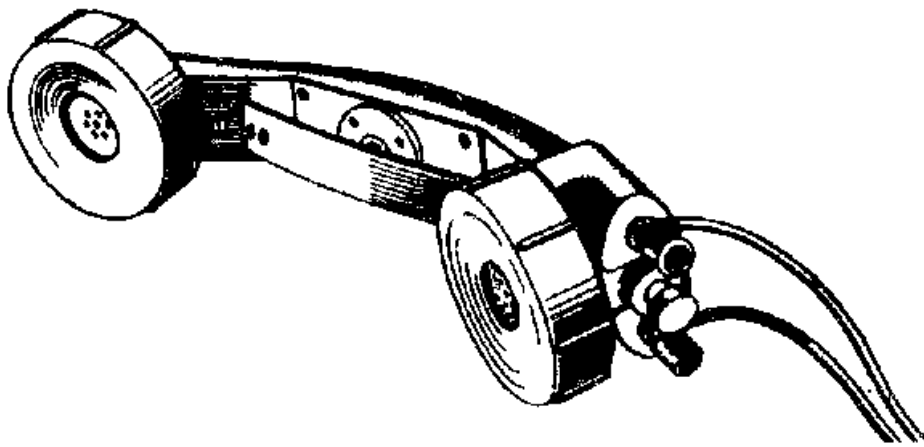

Figure 7

Telephone, Hand, Remote Control No. 1

- 15. This handset is used by an operator at the distant end of the remote control cable. The handset is made of a hard, green plastic material and contains one microphone and one receiver element.
- 16. The handset is fitted with two cable terminals for connection to the remote control cable. Correct polarity is not essential on the cable to the remote control handset, and each termination of cable may be attached to either terminal.
- 17. A call button on the handset operates a buzzer in the junction box, and is pressed by the distant user when he wishes to call the local operator. When the handset press-to-talk switch is operated by the distant user, the pre-selected radio set is automatically switched from receive to send.
- 18. A local operator can call the distant user by turning the switch on his junction box to CALL. This causes a buzzer to function and be fed into the phone of the remote handset through the IC amplifier, producing a signal loud enough to be heard at a range of several metres. Then with this switch at position "I", intercommunication is possible between local and distant operators.

1 - 11/. Any

RESTRICTED

1 - 11

Any other extensions (boxes) switched to "I" can join in the conversation. Similarly, when a radio set is being controlled from a remote point, other extensions can over-hear by switching to the same set.

Connector 12 pin, No. 88 (9.14 metres - 30 feet)

19. A 12 pin audio extension lead to enable the crew commander's microphone to be used some distance away from the control harness. Two of these extensions can be joined together, however if more are used it will impair the efficiency of the equipment. These extension leads can only be used for connecting microphones or further 12 pin extension leads.

Connector 6 pin No. 35 (9.14 metres - 30 feet)

20. Same as the 12 pin except that it is a 6 pin and is used to connect the crewmen's No. 6 microphone.

Adaptor Unit, One Set "O"

21. If this unit is used in a control harness, the set that is selected will automatically go to send without a press-to-talk switch being operated. Therefore, it can not be used as a harness control unit.

VOLTAGE CONTROL RELAY

General

22. The Voltage Control Relay used in the B1 Control Harness is exactly the same as the ones used in the B2 and A2/3 Control Harnesses. Radio sets are sensitive to power voltage changes. Falling low tension will cause, in addition to loss of power, tuning instability and loss of alignment between the transmitter and receiver. In practice, vehicle installations power voltages which are normally 24 volts, may vary between 20.7 and 29 volts; therefore a voltage control system is incorporated in the radio set power supply units and in harness junction boxes. This system maintains the power voltage within reasonable limits. These limits are as follows:-

- a. Low Range. 20.7 to 25.5 volts
- b. High Range. 23.5 to 29 volts

Note:

The voltage ranges (referred to as High and Low Tap) are selected to allow for voltage variations where vehicle charging circuits, or power take-offs are in use. Radio batteries not on charge will almost always be in the low range (Low Tap).

Operation

23. For the purpose of explanation, assume that a J1 Control Unit is being discussed (this information applies equally to the J2 and JD9 Control Units). Incorporated in the J1 is a voltage controlled switch called RELAY "A" and in the radio set power supply

RESTRICTED

1 - 12/. (diagram)



**RESTRICTED**

1 - 12

**BATTERY IN HIGH VOLTAGE RANGE**

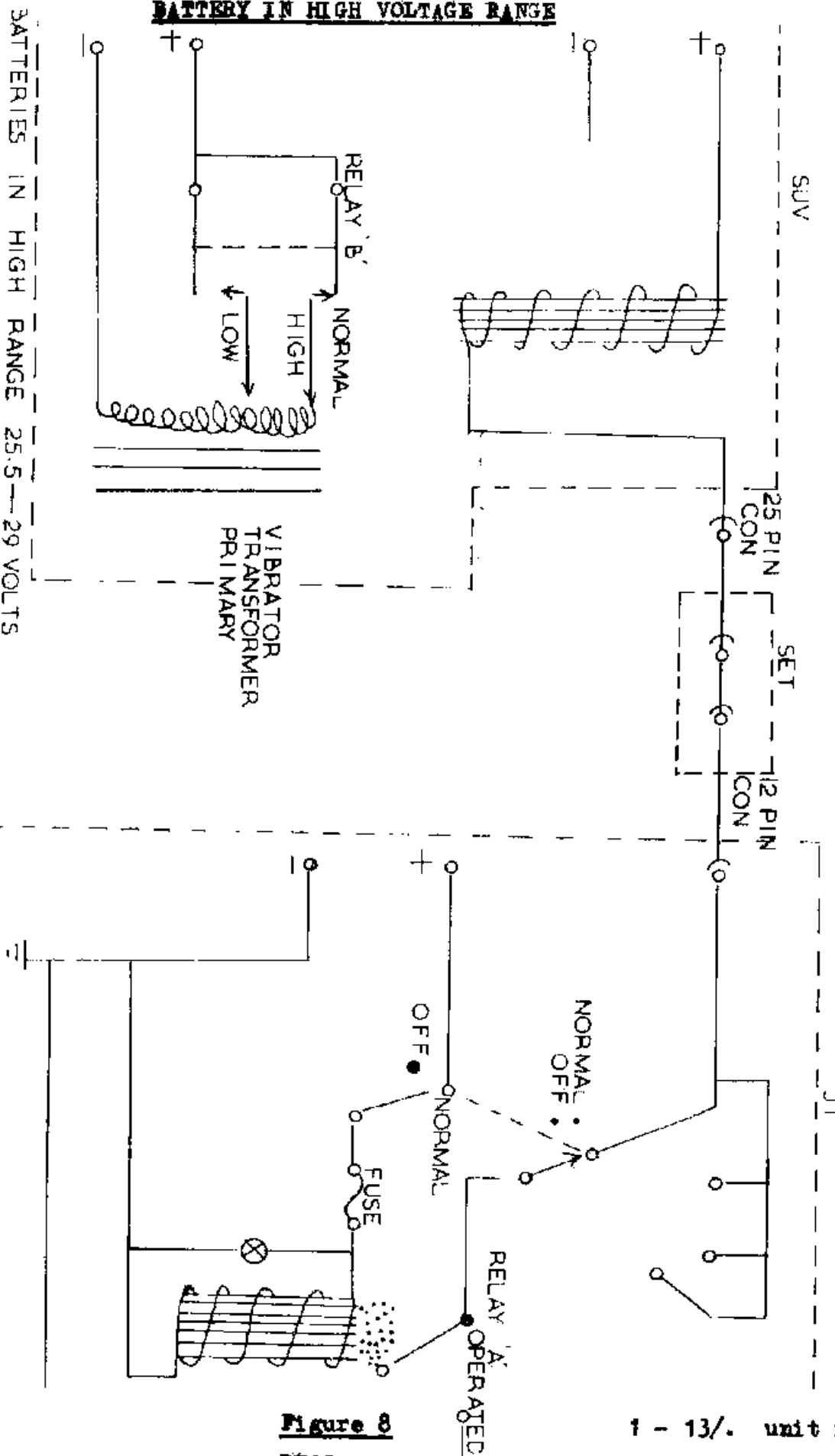

**Figure 8**

**RESTRICTED**

1 - 13/. unit is

RESTRICTED

1 - 13

unit is a voltage controlled switch called RELAY "B". Both these relay switches are held in the NORMAL position by their own spring tension.

Action When Battery Voltage is High (See Figure 8)

24. Assuming that the voltage input to the J1 from the batteries is 27 volts (HIGH RANGE), a circuit is made along line "H" through the 2 ampere fuse to the electromagnet (EM2). This electromagnet is so designed, that when it receives voltages between 23.5 and 29 volts, it will attract the relay switch "A" to it, thus breaking the circuit along line "L" to the SUV. With the circuit broken, the electromagnet (EM1) no longer attracts relay "B" switch, allowing this switch to return to its normal position (HIGH TAP), i.e., using ALL the transformer primary windings, thus allowing the SUV transformer to maintain a normal output from an increased input.

Note:

An overlap of two volts exists between the two ranges. If when an installation is first switched on, the batteries lie within the overlap, the voltage control relay "A" will remain in its normal or low tap position until the voltage rises above the upper limit of the low range.

Action When the Battery Voltage is Low (See Figure 9)

25. Assuming that the voltage input to the J1 from the batteries is 22 volts (Low Range), it will be seen from the diagram that a circuit is made along line "L" to the electromagnet (EM1) in the SUV. This electromagnet is so designed that when it receives voltages between 20.7 and 25.5 volts it will attract the relay "B" switch to it, thus causing this switch to select Low Tap, i.e., fewer transformer turns on the transformer primary windings, thus allowing the SUV transformer to maintain a normal output from a reduced input.

System Faults

26. a. Harness Switched Off. With the harness switched off, there is no current flowing in the voltage control line, which means that the electromagnet (EM1) in the SUV is unable to activate relay "B", so this relay remains in its normal position (High Tap, i.e., INCREASED RESISTANCE). Therefore, if power voltage is low, poor set performance can be expected unless the batteries are in a high state of charge.
- b. Blown 2 Ampere Fuse in Junction Box. Realizing that when the battery voltage is in the high range, the electromagnet (EM2) circuit "H" is in use and having the 2 Ampere fuse also in the circuit, a break in this circuit caused by a blown fuse will result in the relay "A" returning to its normal (Low Tap) position. This now allows relay "B" to be activated (Low Tap) irrespective of the input voltage. This situation could cause serious damage to the set. (See Figure 10).

1 - 14/.(diagram)

RESTRICTED

RESTRICTED

1 - 14

BATTERIES IN LOW RANGE

BATTERIES IN LOW RANGE 20.7—23.5 VOLTS

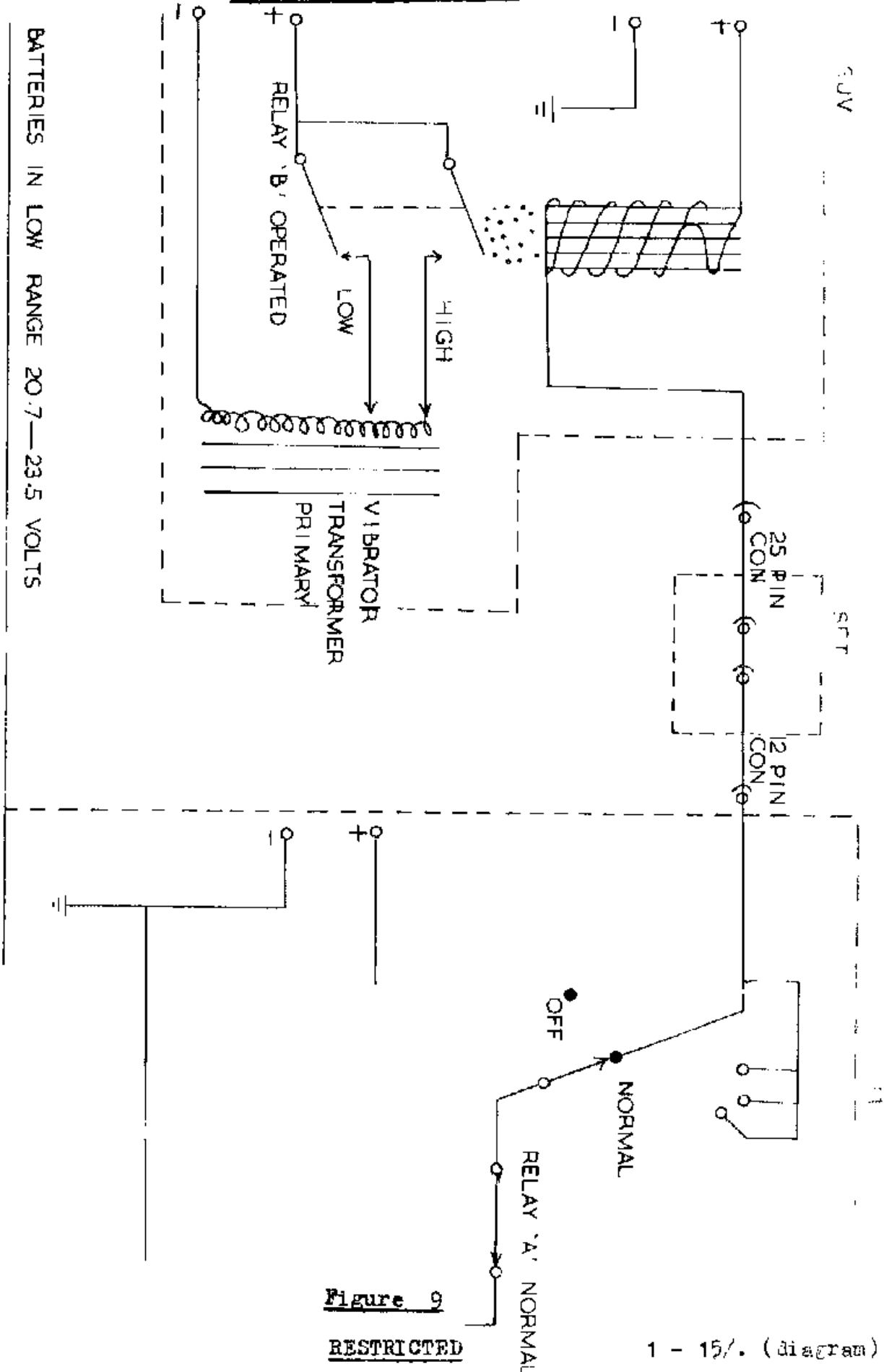

Figure 9

RESTRICTED

1 - 15/. (diagram)

RESTRICTED

1 - 15

BLOWN FUZE

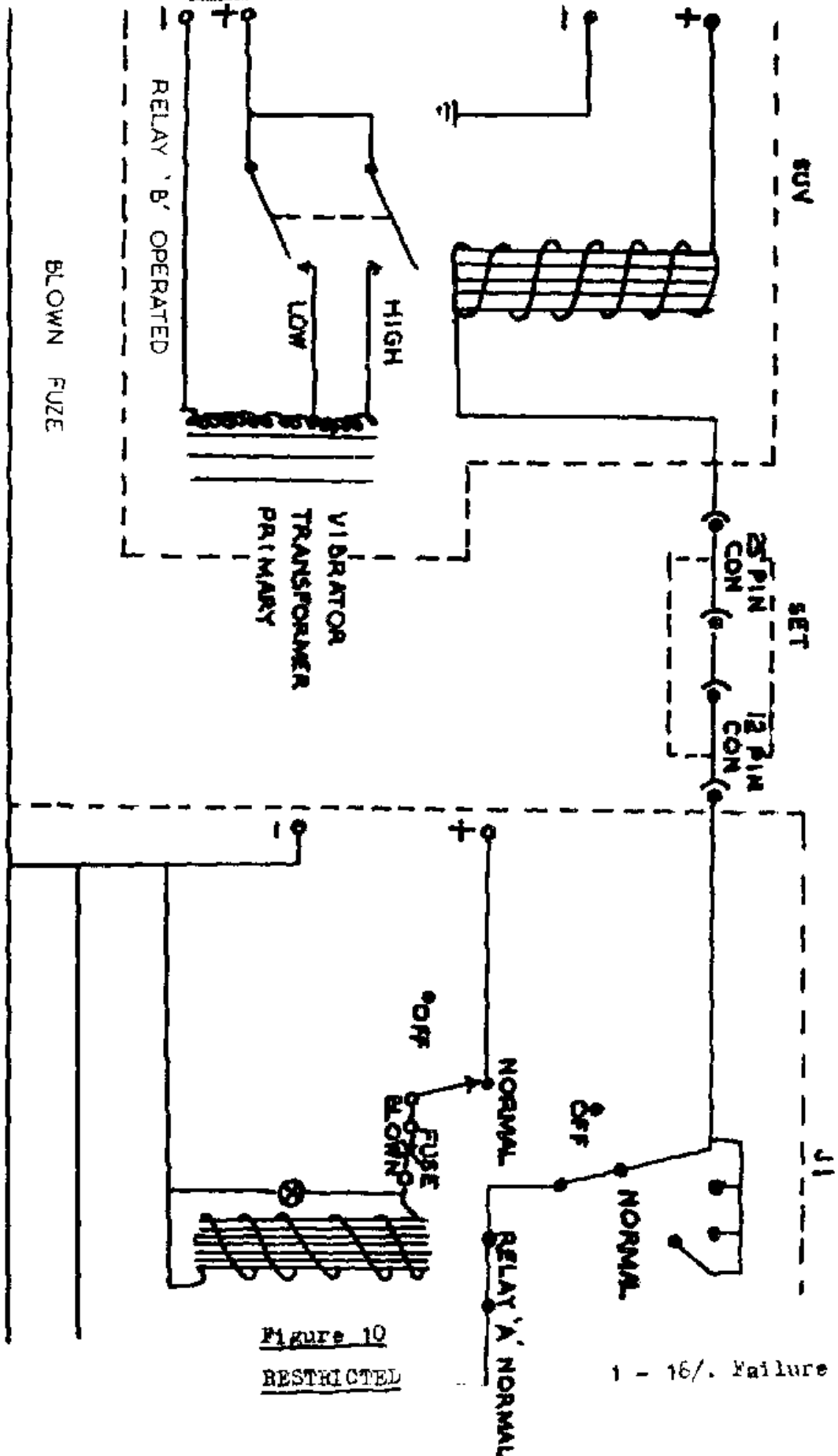

Figure 10

RESTRICTED

1 - 16/. Failure

RESTRICTED

1 - 16

- c. Separate Power Supply to Set and Harness. Failure to connect both set and harness to the same source of input voltage could lead to the wrong selection of SUV transformer tapping, since the operation of relay "B" depends upon the voltage fed into the harness and NOT upon that fed into the set.

DRILLS AND TESTS

Opening Up Drills

27. The Opening Up Drills on the B1 Control Harness are as follows:-

- a. Ensure that the centre switch on the J1 is at NORMAL.
- b. Ensure that the radio set is connected to the J1 and that the set has been tested and tuned.
- c. Check the security of all junction boxes and control units.
- d. Check the security and condition of all cables and leads.
- e. Check the security and operation of all switches and controls.
- f. Check the Dessicator on the J1 for discolouring (if it has turned a pink colour - report).
- g. Connect the crewmen's and commander's microphones to the required connectors. (Ensure that the microphones have been previously tested).
- h. Connect Remote Handset to the remote control terminals and check the condition of the remote cable being used.
- i. Ensure that the equipment is clean and check the condition of all spare equipment. (Ensure that the spares are properly stowed).
- j. Carry out the Tests.

Tests

28. Some of the tests required that the radio set be put to send, therefore no tests will be carried out during periods of Electronic or Radio Silence. The tests on the B1 Control Harness are as follows:-

1 - 17/. (Tests)

RESTRICTED

RESTRICTED

1 - 17

Part Tested	Step	Test	Result	Fault	Action
a. Power Supply (LT)	(1)	Switch "J1" to <u>NORMAL</u>	Lamp Lights	No Light	a. Check fuse and change if necessary. b. Check bulb and change if necessary. c. Adjust shutter. d. Report.
b. "J1" Remote Handset IC  <u>Ensure to used tested headsets.</u> Connect remote handset.  Connect (if needed) "C" and/or "D" Box	(1)	Operate <u>CALL</u> switch	Buzz in Headset	No buzz in Headset	a. Check gain control. b. Check that headset is plugged in. c. Report.
	(2)	"J1" at " <u>I</u> " Press press-to-talk switch. Speak into microphone	Side tone heard	No side tone	a. Check SUV for "IC" switched on. b. Check headset plugged in. c. Report.
	(3)	"J1" at " <u>SET</u> " Noise on/off to on (Check-set) Vary volume	Mush heard and varies	No mush No variation	a. Check headset plugged in. b. Report.
	(4)	<u>NOISE ON/OFF SWITCH</u> (Set) to "Off". Press press-to-talk switch and speak	Side tone heard and ATU meter rises	No side tone No deflection	a. Check headset plugged in. b. Check lead from set to ATU. c. Report.
	(5)	"J1" to <u>REMOTE</u> Operate remote handset call button	Buzz in headset	No buzz	a. Check cable. b. Check connections. c. Check handset. d. Report.
	(6)	"J1" to " <u>I</u> " Press press-to-talk switch on remote handset and speak	Side tone heard in "J1" operator headset	No side tone	a. Check headset plugged in. b. Check handset press-to-talk switch. c. Report

RESTRICTED

1 - 18/ "J1" to

RESTRICTED

1 - 18

Part Tested	Step	Test	Result	Fault	Action
	(7)	"J1" to "BK IN" L/H switch to set Press press-to-talk switch on microphone	ATU meter rises	No deflec- tion	Report
	(8)	"J1" to "RRE" Press press-to-talk switch on remote handset	ATU meter rises	No deflec- tion	Report
c. "C" Box	(1)	Operate "C" Box <u>CALL</u> Switch	Buzz heard in all head- sets	No buzz	Report
	(2)	Select "I" on "C" Box and speak	Side tone heard in all headsets	No side tone	a. Check "I" on J1. b. Report
	(3)	Select "B" on "C" Box. Stop check screw Noise on/off switch (Set) to "on". Vary volume on "C" Box	Mush heard and varies	No mush No variation	Report
	(4)	Noise on/off switch (Set) to "off". Press press-to-talk switch and speak	ATU meter rises Side tone heard	No deflec- tion No side tone	Report
d. "D" Box	(1)	Operate "D" Box <u>CALL</u> Switch	Buzz heard in all headsets	No buzz	Report
	(2)	Select "I" on "D" Box. Press press-to- talk switch and speak	Side tone heard in all head- sets	No side tone	a. Check "I" on J1. b. Report.
	(3)	Select "B" on "D" Box. Noise on/off switch to "on". Vary volume on "D" Box	Mush heard and varies	No mush No variation	Report
e. "T" Box	(1)	Select "B" on "C" Box or J1 (whichever one the "T" Box is connected to) and press the press-to- talk switch and speak into the micro- phone	ATU meter rises and side tone is heard	No deflec- tion No side tone	Report

RESTRICTED

1 - 19/. Operate

Part Tested	Step	Test	Result	Fault	Action
	(2)	Operate call buzzer on J1 or "C" Box	Buzzer heard in headphones	No buzz	Report
	(3)	Select "I" on J1 or "C" Box and get second operator to converse on the IC	Voice heard	No voice	Report
f. 9.14 meter extension leads	(1)	Connect 12 and 6 pin extension leads to J1 or "C" Box. Connect commander's and crewmen's microphones to respective leads. Select "B" on J1 or "C" Box, press the press-to-talk switch and speak into microphone	ATU rises side tone heard	No deflection or No side tone	Change extension lead  Report

Operation

29. The operating procedures for the B1 Control Harness are as follows:-

- a. Remote Working. To use the remote facility, carry out the followings:-
- (1) Unscrew the remote terminals on the J1 and handset.
  - (2) Remove approximately  $\frac{3}{8}$  inch (14 millimeters) of the plastic coating from the end of the D10 cable.
  - (3) Insert the D10 cable into each remote terminal and screw in the outer sleeve. Ensure that the serrated teeth bite into the cable core. DO NOT screw the terminals up too tightly as you may rotate the complete terminal assembly and cause damage.
  - (4) Ensure the complete length of D10 cable is in good condition. (If the wires are bared and they touch, the set will go to send if the J1 is at SET).
  - (5) Select the required position on the left-hand switch on the J1 and switch the centre switch to REMOTE. The remote is now ready for use.
- b. Remote Automatic Rebroadcast. To set up Remote Automatic Rebroadcast, carry out the followings:-
- (1) Set up two B1 harnesses within 200 meters of each other (the closer the better).



RESTRICTED

1 - 20

- (2) Ensure that the radio set in each installation is a VHF and that both have similar squelch circuits.
- (3) Tune both sets to the required frequencies (ensure that the frequencies are no closer than 3 mhz apart and not in multiples of 6 mhz).
- (4) Ensure that both squelch circuits are accurately adjusted.
- (5) Switch both J1s to SET and RRB.
- (6) Cut a length of D10 cable (no longer than 200 meters) and remove approximately 14 millimeters ( $\frac{1}{2}$  inch) of plastic coating from the four ends. Ensure that the remainder of the length of cable is in good condition.
- (7) Unscrew the remote terminals on one J1 and insert one end of the cable. Screw in the outer sleeves.
- (8) Test for polarity by touching the other end of the cable onto the terminals of the second J1. If the set goes to send, swap the wires over to the opposite terminals and insert them and screw up the outer sleeves, if not, insert the cable into the same terminals.
- (9) The remote automatic rebroadcast circuit is now set up and distant stations can now communicate on the two different frequencies.
- (10) For the operator on the RRB installation to transmit over both frequencies, switch to BREAK-IN and transmit. As soon as the transmission is finished, switch back to RRB otherwise, the rebroadcast will be served.
- (11) If both operators on the two E1 harnesses wish to talk to each other on the IC, one operator will operate his CALL buzzer and switch to REMOTE. The second operator upon hearing the call buzzer will switch to Remote and "I". (The first operator will also have his J1 at "I"). The two operators can now converse on the IC. This particular procedure is not advisable when RRB is taking place as the rebroadcast is disrupted.

Closing Down Drill

30. The Closing Down Drill for the B1 Control Harness is as follows:-

- a. Switch the centre switch on the J1 to OFF.
- b. Remove and stow all microphones (if closing down for a long period of time).
- c. Check the condition of all junction boxes, control units and replace/report if necessary.

**RESTRICTED**

1 - 21

- d. Clean and dry all equipment.
- e. Check the condition and stowage of all spares.

**Note:**

Ensure that the radio set is switched off prior to switching the harness off.

**REMOTE AUTOMATIC REBROADCAST INSTALLATION**

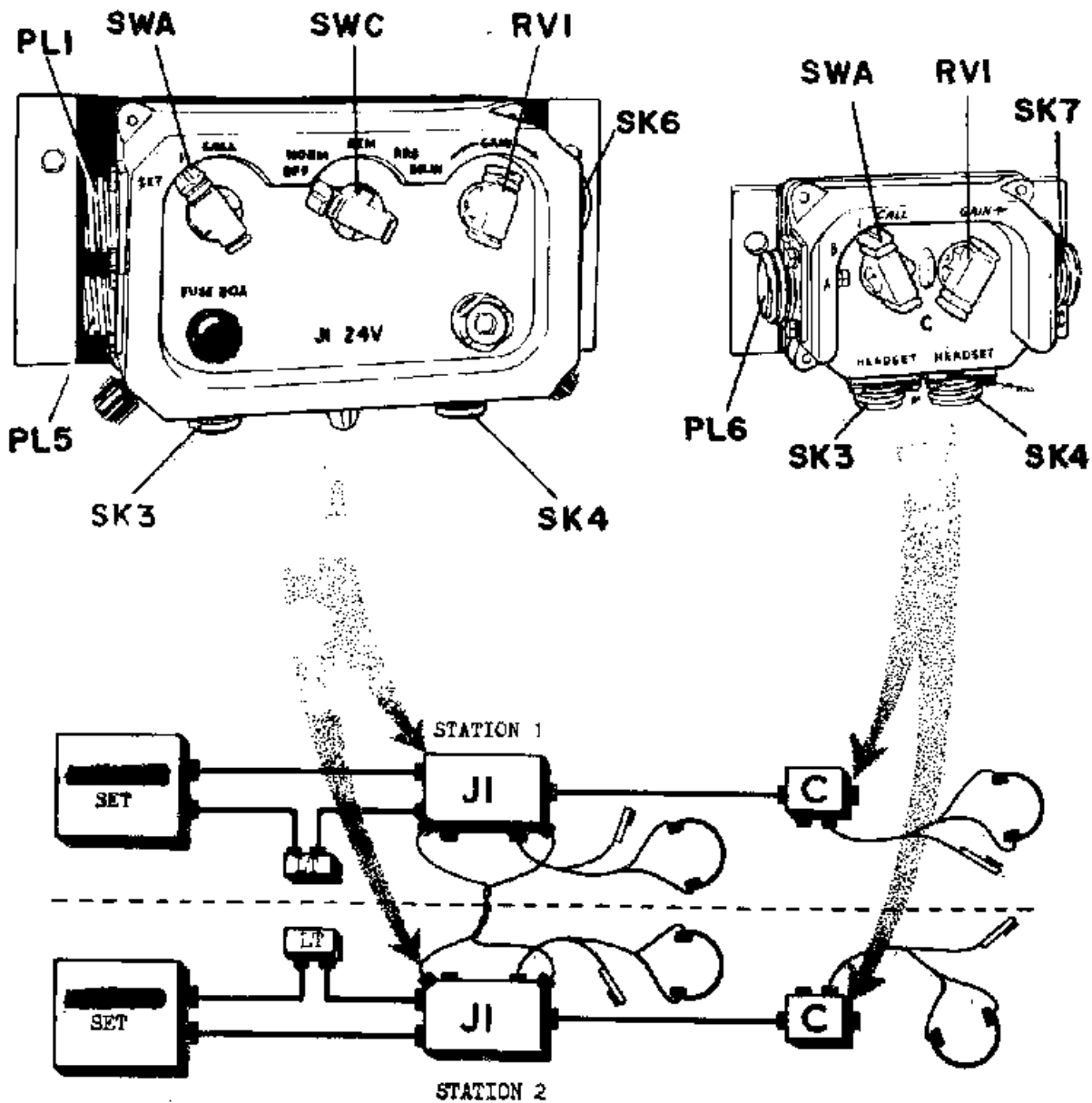

**Figure 11**  
**RESTRICTED**

RESTRICTED

2 - 1

CHAPTER 2 - B2 CONTROL HARNESS

General

31. The B2 Control Harness is a two set installation that is used in armoured cars, scout cars and other vehicles where control over two sets is required. This harness, as is the B1 harness is being phased out and replaced by the American type installations.

Facilities

32. The facilities provided by the B2 Control Harness are as follows:-

- a. Control of Two Sets. Enables the crew members to transmit and receive on either set.
- b. Intercommunication (IC). Enables the crew members to communicate with each other without transmitting over a radio set. One of the sets must have an IC amplifier and this set must be the "A" set.
- c. Call System. To enable the crew members to attract each others attention.
- d. Remote Control. Either set and the IC can be used remotely via a handset connected to the harness by D10 cable. The maximum usable distance is 1000 metres.
- e. Local Automatic Rebroadcast. Enables automatic rebroadcast to take place between the two sets in the installation. Both sets must be VHF and have similar squelch circuits.
- f. Local Manual Rebroadcast. Enables manual rebroadcast to take place between the two sets in the installation. Both sets are of a dissimilar squelch. (i.e., RS C42 and RS C13). With this type of rebroadcast, one set is manually forced to go to send by manipulating switches on the applicable control unit in the harness.
- g. Remote Automatic Rebroadcast. Enables automatic rebroadcast to take place between two VHF sets with similar squelch circuits in separate installations. The two installations are joined by wire.
- h. Break-in. Enables the crewmen to transmit over both sets during rebroadcast.
- i. Voltage Control Relay. Refer to Chapter 1, para

Power Requirement

33. The power required to operate the B2 harness is 24 volts d.c (direct current), and the power consumption is approximately  $\frac{1}{2}$  to 1 ampere. The harness is powered separately from the radios, however, the power source for the harness and sets must be the same. The

RESTRICTED

2 - 2/. harness

RESTRICTED

2 - 2

harness can be powered by either a vehicle generating system, radio batteries or mains rectifier.

Configuration

34. The B2 harness, like the B1 harness, is not restricted to any set configuration as control units can be added or removed to suit the requirement (i.e., "T" boxes, "D" boxes and "C" boxes).

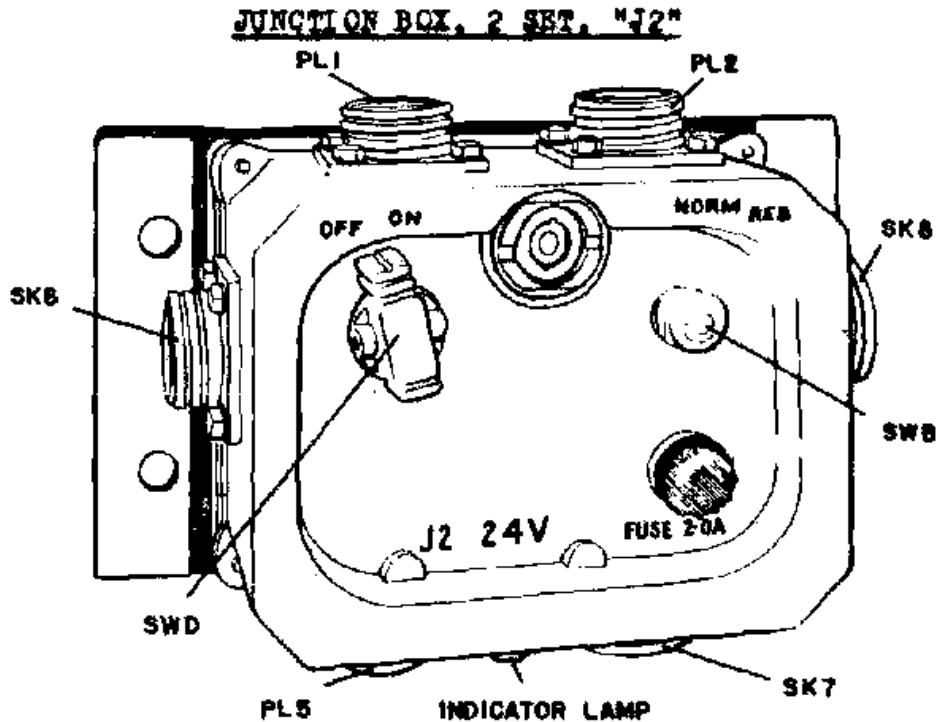

Figure 12

Component Construction

35. Each control unit and junction box is of similar cast aluminium construction, although the sizes and shapes vary according to the function of the unit. Each box is hermetically sealed to render it moisture and dust proof, and is mounted on a flexible base by means of which it is secured in a convenient position in the vehicle. Desiccators are fitted in Junction boxes and in the Control Unit "R" to absorb residual moisture. Each box and unit is clearly marked with the designation by which it is identified (i.e., "C", "D", "R" etc.). All controls and switches are fitted to the fronts of the units. Plastic, screw on dust covers are provided on all boxes and units to cover connections when not in use. Earthing straps are fitted to all flexible bases.

2 - 3/. This junction

RESTRICTED

RESTRICTED

2 - 3

Junction Box, 2 Set, "J2" (See figure 12 )

36. This junction box is for the connection of two radio sets into an installation. It has two 12 pin plugs, PL1 and PL2, for the connectors to the two radio sets. PL1 is for the "A" set (this set must have the IC as the IC is fed into the harness via this socket), and PL2 for the "B" set. A 25 pin socket (SK8) on the right hand side provides the connection for the "R" box or "B" box (the "B" box can be used without the "R" box or "B" box (the "B" box can be used without the "R" box being part of the harness). On the bottom of the J2 a 2 pin plug (PL5), for power input and a 12 pin plug (SK7), for connection to either a commanders microphone, "C" box or "D" box are provided. One 12 pin connector (SK6), is fitted to the left hand side to enable either a commanders microphone, "C" or "D" box to be fitted.

Switches and Control on Face of J2

37. The switches and control on the J2 are as follows:-
- a. Power Switch. This switch has two positions (OFF and ON). This switch is used to switch power to the harness OFF or ON.
  - b. Dessicator. A moisture absorber fitted with a glass gauge to indicate the degree of absorption. When the indicator (a form of blotting paper) turns from white to pink, the dessicator has reached maximum absorption and must be reported for repair.
  - c. REB Switch. A screwdriver operated switch with two positions - NORM (normal) and REB (rebroadcast). It is fitted with a see-through plastic, screw on cover. When a "B" box is fitted this switch must be in the REB position so that the crew members cannot inadvertently transmit when rebroadcast is taking place. In the REB position, and rebroadcast is taking place, it stops crew members from transmitting in all control unit positions of "A" and "B" until "BREAK-IN" is selected on the "B" box.
  - d. Fuse. a 2 ampere fuse is contained in a screw in plastic cap. The symptoms of a blown fuse are as follows:-
    - (1) VCR selects low tap.
    - (2) No send on the Remote Handset.
    - (3) Low tension indicator lamp goes out.
    - (4) No call buzzer.
    - (5) No send on RRB (if using a second installation to set up remote automatic rebroadcast).

2 - 4/. When

RESTRICTED

RESTRICTED

2 - 4

- e. Low Tension Indicator Lamp. When illuminated, it indicates that low tension power is present to the J2. It is fitted with a dimmer shield for blackout purposes. The red plastic cover houses a 28 volt 0.04 amperes pea bulb. The bulb is easily replaced by removing the cover.

REMOTE CONTROL UNIT "R" (See figure 13)

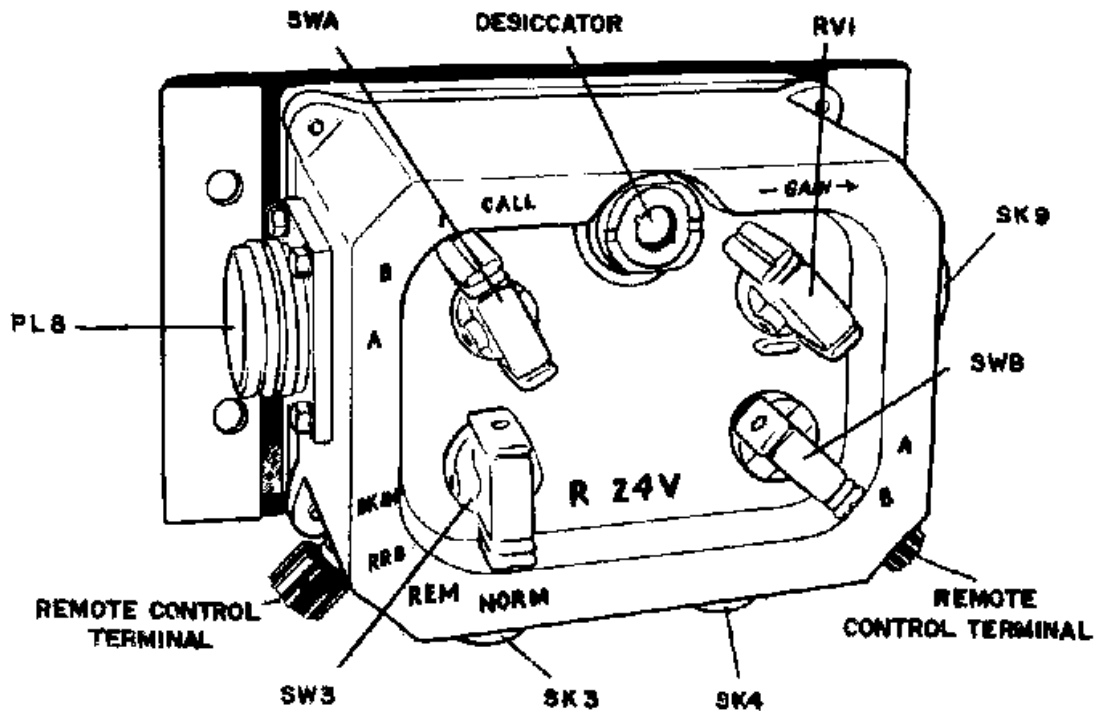

Figure 13

Remote Control Unit "R"

38. This unit is a combination of a "C" box and a J1. It is fitted with two 25 pin connectors (PL8 and SK9). The 25 pin (PL8), enables the "R" box to be connected to the J2 and the 25 pin connector (SK9), provides a connection to the "B" box (a second "R" box can be fitted instead of a "B" box). Two 6 pin crewmans No. 6 microphones and/or Adaptor Unit "T"s. Two screw-in remote control terminals are located on the bottom left and right hand corners for the connection of D10 cable for remote workings. The left hand terminal is marked (-) negative and the right hand one (+) positive. Polarity is not essential when connecting the remote handset, however, it is when setting up Remote Automatic Rebroadcast with a second installation. If polarity is incorrect, both sets will go to send.

2 - 5/. The switches

Switches and Controls on the "R" Box

39. The switches and controls on the "R" box are as follows:-
- a. Top Left-Hand Switch. This switch has four positions. These are:-
    - (1) "A". Enables the user to transmit and receive on the "A" set.
    - (2) "B". Enables the user to transmit and receive on the "B" set.
    - (3) "I". Enables the user to receive and speak on the intercommunication system (IC).
    - (4) Call. This is a spring-loaded position. When the switch is released from the CALL position it will automatically return to "I". When held at CALL, it will operate a call buzzer that will be heard by all persons attached to the harness, regardless of which position they are switched to.

Note:

In the positions of "A", "B" and "I", you cannot monitor any other switch position i.e., if you had "I" selected, you could not hear the "A" or "B" sets.

- b. Dessicator. Same as dessicator on the J2. Refer to para 37 for description.
- c. Top Right-Hand Switch. A gain control. Will adjust the volume of the microphones connected to the two 6 pin connectors on the bottom of the "R" box. Rotated clockwise to increase the volume.
- d. Bottom Right-Hand Switch. This switch controls the set selector for the remote handset. The two switch positions are as follows:-
  - (1) "A". Enables the remote operator to transmit and receive on the "A" set.
  - (2) "B". Enables the remote operator to transmit and receive on the "B" set.

Note:

For the remote operator to use the IC, he has to operate the call buzzer on his remote handset to attract the attention of the operator at the "R" box. Upon hearing the call buzzer, the "local" operator will switch the top left-hand switch to "I". The remote handset will now be on IC. Naturally, the local operator will also be on IC until the remote operator no longer requires the use of the IC. As long as the "R" box is at "I", the bottom right-hand switch is inoperative.

2 - 6/. This switch

RESTRICTED

2 - 6

- e. Bottom Left-Hand Switch. This switch allows the use of remote workings and remote automatic rebroadcast. The four switch positions are as follows:-
- (1) NORM (normal). In this position the remote circuit is disconnected. All other facilities are as for normal.
  - (2) REM (remote). Remote circuit connected and all other facilities are as for normal.
  - (3) RRB (remote automatic rebroadcast). Only used for remote automatic rebroadcast with a second installation connected by D10 cable (either a J1 or "R" box).
  - (4) BK-IN (break-in). Enables the user to transmit over both sets when using remote automatic rebroadcast.

REBROADCAST UNIT "B"

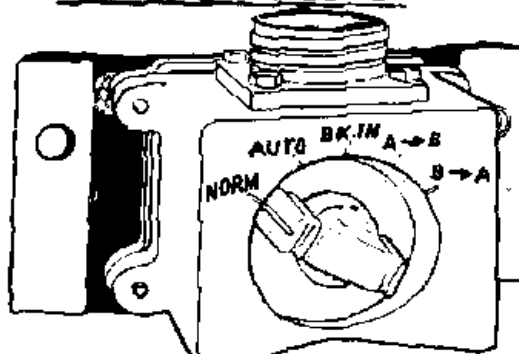

Figure 14

Rebroadcast Unit "B" (See Figure 14)

40. This control unit is used to control Local Automatic and Local Manual rebroadcast. It has a 25 pin connector on the top to enable it to be connected to either a J2 or an "R" box. The five positions on the "B" box are as follows:-

- a. NORM (normal). Crew members send-receive press to talk switches are connected ready for operating the individual sets. No local rebroadcasting facilities are available.
- b. AUTO (automatic). Rebroadcasting is automatic between two VHF sets with similar squelch circuits. Both sets must be in the same installation. Sets must have frequencies no closer than 3 mhz and not in multiples of 6 mhz.
- c. BK-IN (break-in). An operator at "C" box, "R" box or connected directly to the J2 with a commander's

RESTRICTED

2 - 7/. microphone



RESTRICTED

2 - 7

microphone can transmit over both sets in the rebroadcast. (Remote operator can also transmit over both sets if he is on either "A" or "B" set).

- d. A - B. Used for manual rebroadcast between sets with dissimilar squelch circuits. Both sets must be in the one installation. In this position, the "A" set is receiving a signal and the "B" set has been forced to "send". The received signal is sent out over the "B" set. The "B" set will remain at "send" until the switch (A - B) has been moved to another position.
- e. B - A. As for para d. above except that the "B" set is receiving a signal and the "A" set is forced to "send". The "A" set will continue to "send" until the switch (A - B), has been moved to another position.

Note:

When using manual rebroadcast, the switch must be left at BK-IN so that the local operator can hear which of his two sets is receiving. If for example, the "A" set commenced to receive, he would switch from BK-IN to A - B. If an answer was required, the local operator would then switch from A - B to B - A to force the "A" set to go to send. Upon hearing an "OUT" given, the local operator would then switch back to BK-IN and wait for the next received signal to determine which way to switch.

CONTROL UNIT, OPERATORS "C"

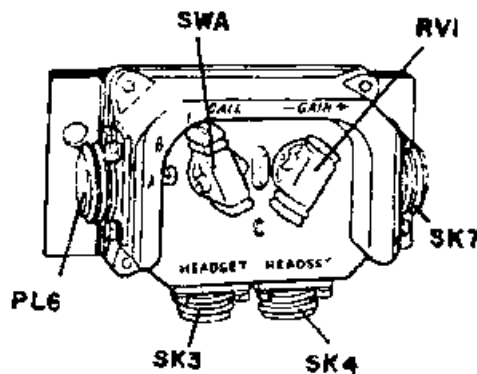

Figure 15

2 - 8/. This unit

RESTRICTED

RESTRICTED

2 - 8

Control Unit, Operators "C"

41. This unit is the Operator's control box. It is fitted with a 12 pin plug, (PL6), to connect either a Commander's microphone or another "C" or "D" box. A second 12 pin plug, (SK7), is used to connect the unit to either the J2 or a "C" or "D" box. Two six pin sockets, (SK3 and SK4), are provided for the connection of crewmen's microphones or "I" boxes.

"C" Box Switches and Controls

42. The "C" box has two switches/controls, and these are:-

a. Left-Hand Switch. This switch has four positions. They are:-

- (1) "A". Enables the operator to transmit and receive on the "A" set.
- (2) "B". Enables the operator to transmit and receive on the "B" set.
- (3) "I". Enables the operator to communicate with other crew members on the IC.
- (4) CALL. A spring loaded position. The switch will return to "I" if not held at CALL. When held at CALL, it operates a call buzzer on the IC circuit, and all crew members will hear the buzzer regardless of the setting on their control unit.

Note:

The "C" box does not have a monitor facility. If for example, the "A" set was selected, you could not hear the IC or the "B" set.

b. Right-Hand Control. This is a gain control to adjust the volume of the microphones connected to the unit. Rotate the control clockwise to increase the volume.

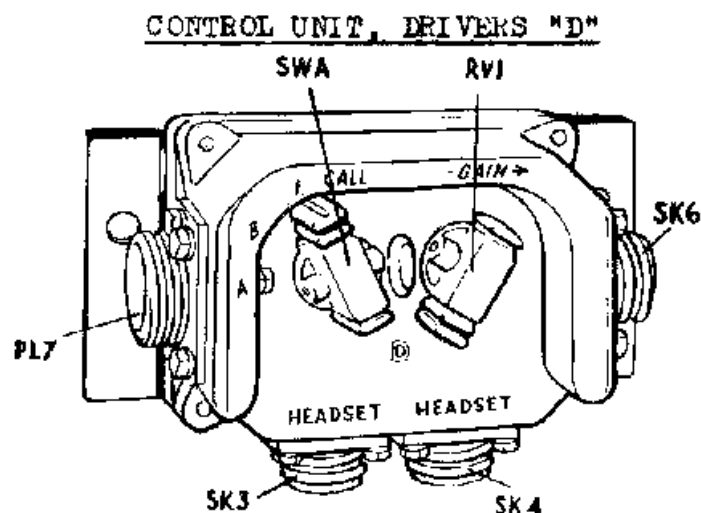

Figure 16

RESTRICTED

- 9/. This unit

RESTRICTED

2 - 9

Control Unit, Drivers "D"

43. This unit is externally the same as the "C" box except that it has the letter "D" on the face of it. This unit is used by the driver or co-driver. Refer to para 41 for a description of the connectors.

"D" Box Switches and Controls

44. The "D" box has two switches/controls. These are as follows:-

- a. Left-Hand Switch. This switch has four positions. These are:-
  - (1) "A". Enables the driver to listen to the "A" set and hear the intercom. Cannot transmit on either the "A" set or IC.
  - (2) "B". Enables the driver to listen to the "B" set and hear the intercom. Cannot transmit on either the "B" set or IC.
  - (3) "I". Enables the driver to speak and hear on the intercom circuit.
  - (4) CALL. As for the "C" box.
- b. Right-Hand Control. Adjusts the volume. As for the "C" box.

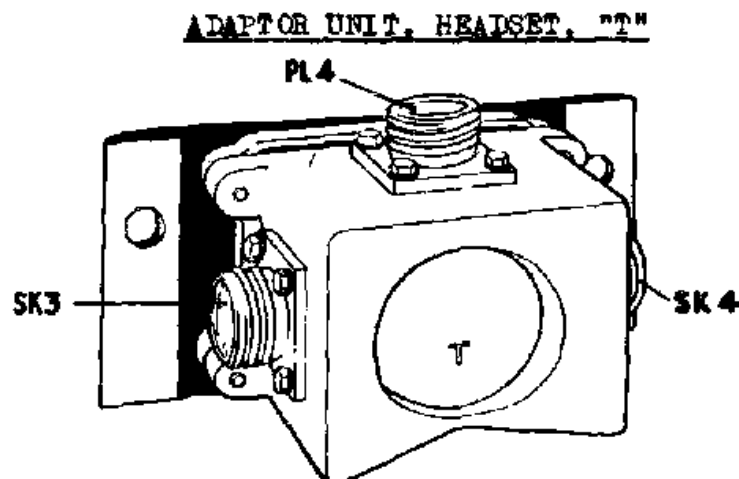

Figure 17

Adaptor Unit, Headset, "T"

45. This unit enables the use of two microphones from one 6 pin microphone outlet plug. It has one 6 pin plug (PL4), to connect it to either an "R", "C" or "D" box. It provides two 6 pin connectors (SK3 and SK4), for the connection of microphones,

RESTRICTED

2 - 10

extension leads or further "T" boxes. This unit will have the same facilities as the control unit that it is connected to. (ie., if a "T" box was connected to a "C" box, and the "C" box was switched to "A", then the "T" box would be on "A").

Audio Equipment

46. The audio equipment that can be used in the B2 Control Harness is as follows:-

- a. Microphone Hand SI, No. 6 (crewmens).
- b. Microphone Hand SI, No. 7 (commanders).
- c. Microphone Hand SI, No. 4 (commanders).
- d. Receivers Headgear SI, double No. 1A.
- e. Telephone, hand, remote control No. 1.
- f. 9.14 metre (30 foot), connector 12 pin, No. 88.
- g. 9.14 metre connector 6 pin, No. 35.

MICROPHONE HAND SI, NO. 6 WITH RECEIVERS HEADGEAR SI, DOUBLE NO. 1A

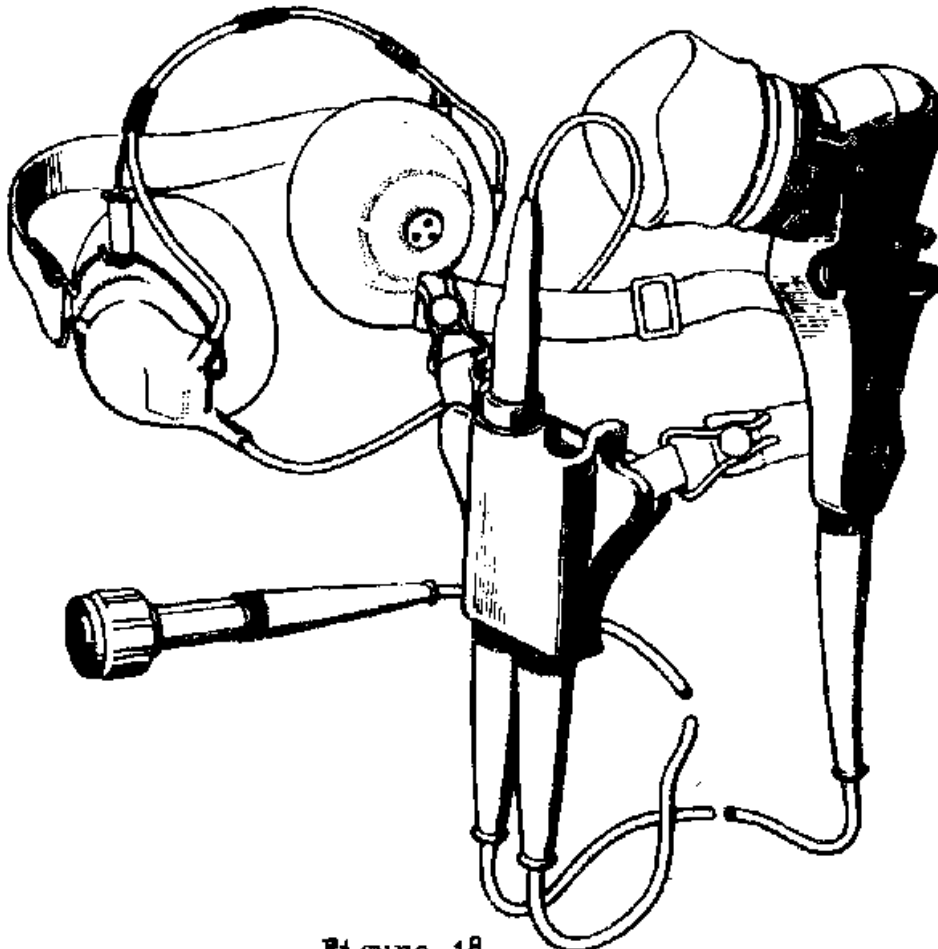

Figure 18

2 - 11/. This is

RESTRICTED

RESTRICTED

2 - 11

Microphone Hand SI, No. 6 with Receiver Headgear

47. This is the microphone and headphones used by all crew members except the commander. Separate connectors from the microphone and receivers are joined at a small junction box (breastplate) which normally hangs from the users neck on a web strap. The junction box can be attached to any 6 pin microphone socket on the control units. A snatch plug connects the receiver phones to the junction box, which is itself attached to the webbing neckband harness by means of stud fasteners. The snatch plug and fasteners will easily part if given a sharp pull. A press-to-talk switch on the microphone performs send-receive switching, this switch being readily manipulated with either hand. A respirator plug socket is fitted to the side of the microphone body. The purpose of this socket is to enable a remote microphone in a respirator mask to be connected to the No. 6. The webbing neck strap and the earphone strap are adjustable. (See figure 19).

MICROPHONE HAND SI, NO. 7 WITH RECEIVER HEADGEAR SI, DOUBLE NO. 1A

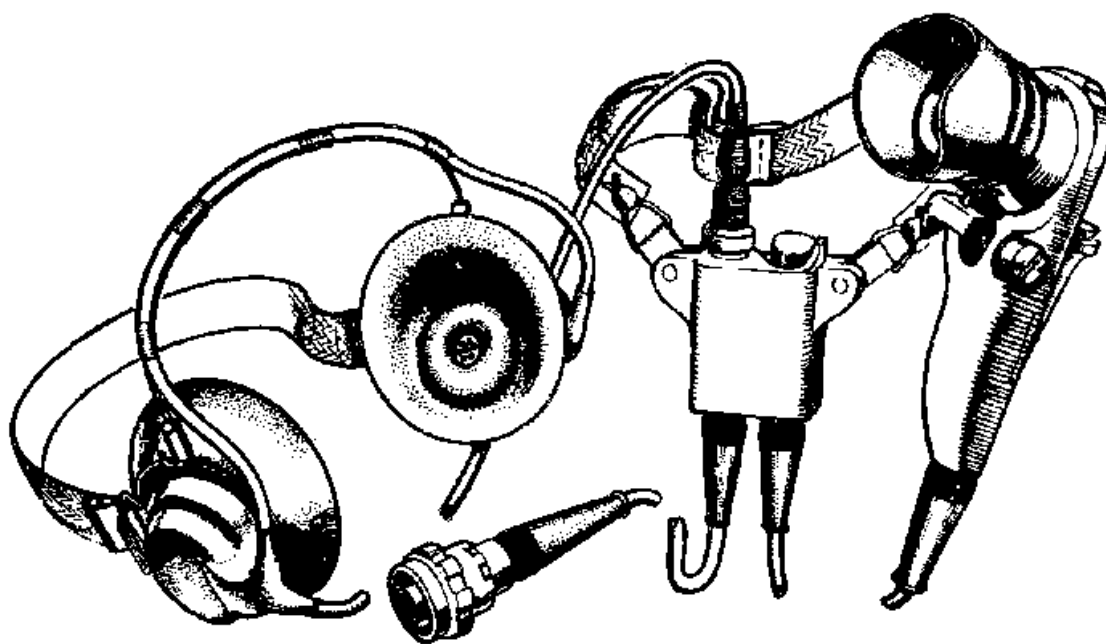

Figure 19

Microphone Hand SI, No. 7 with Receiver Headgear

48. This is the microphone assembly used by the commander. Separate connectors from the microphone and receivers are joined at a small junction box (breastplate) which normally hangs from the users neck on a web strap. The junction box can be attached to a 12 pin socket on the control units in the harness. A snatch plug connects the receiver phones to the junction box, which is itself attached to the webbing neckband harness by means of stud fasteners. The snatch plug and stud fasteners will easily part if given a sharp pull. A press-to-talk switch on the microphone performs send-receive switching, this switch being readily manipulated with either hand. A respirator plug socket is fitted to the side of the microphone body. The purpose of this socket is

RESTRICTED

2 - 12

to enable a remote microphone in a respirator mask, to be connected to the No. 7. The webbing neck strap and the earphone strap are adjustable. A volume control is fitted to the top of the junction box to control the volume level in the earphones. Below the mouthpiece, a thumb operated selector switch is fitted, to enable the commander to select the set or IC he wishes to use. The toggle switch positions are as follows:-

- a. CALL. Enables the commander to operate the call buzzer. This is a spring loaded position, and the switch will return to "I" if released.
- b. "I". Enables the commander to use the IC system.
- c. "B". Enables the commander to transmit and receive on the "B" set.
- d. "A". Enables the commander to transmit and receive on the "A" set. This microphone does not have a monitor facility.

COMMANDER'S MICROPHONE

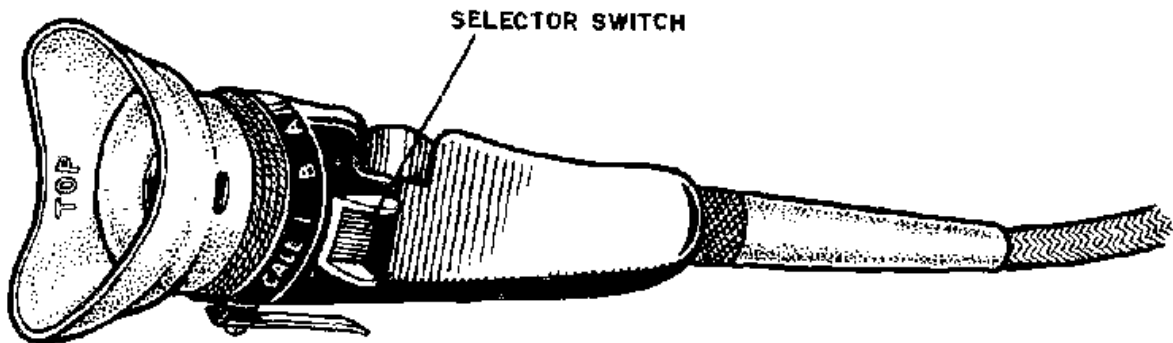

COMMANDER'S MICROPHONE

Figure 20

Note:

The commander's No. 7 microphone will over-ride the "A", "B" and "I" positions on any of the control units that it is connected to. This enables the commander to select the required position on his microphone without having to alter the switch setting on his control unit.

Microphone Hand SI, No. 4

49. This is also a commander's microphone. It is identical to the No. 7 microphone except that it does not have a respirator socket on the side of the microphone body.

2 - 13/. This handset

RESTRICTED

RESTRICTED

2 - 13

TELEPHONE HAND SET, REMOTE CONTROL, No. 1

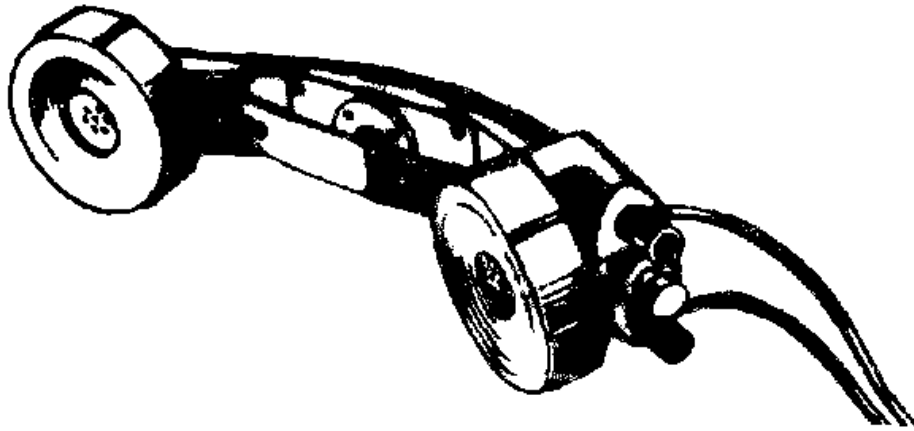

Figure 21

Telephone Hand Set, Remote Control, No. 1

50. This handset is used by an operator at the distant end of the D10 remote cable. The handset is fitted with two screw-in remote terminals for connection to a twisted pair of D10 cables. Correct polarity is not essential on the cable to the remote handset, and each termination of D10 cable may be attached to either terminal. A call button on the handset operates a buzzer in the junction box, and is pressed by the distant user when he wishes to call the local operator. When the handset press-to-talk switch is operated by the distant user, the preselected radio set is automatically switched from receive to send. A local operator can call the distant user by turning the switch on his junction box to CALL. This causes a buzzer to function and be fed into the phone of the remote handset through the IC amplifier, producing a signal loud enough to be heard at a range of several metres. Then with this switch at "I", intercommunication is possible between local and distant operators. Any other person on "I", can also communicate with the distant user.

9.14 Metre Connector, 6 Pin, No. 35

51. This is an audio extension cable to enable the No. 6 crewmans microphone to be connected to it and used up to 9 metres away from the control unit. A maximum of two of these cables can be joined together to increase the distance. On one end of the cable is a 6 pin plug to connect a microphone and on the other, a 6 pin plug to connect to a control unit (ie., "R", "C", "D" or "T" box).

9.14 Metre Connector, 12 Pin, No. 88

52. As for para 51 above, except that it is a 12 pin cable, and is used to connect the commander's No. 4 or No. 7 microphone. (ie., to a "C" or "D" box).

2 - 14/. The opening

RESTRICTED

RESTRICTED

2 - 14

Opening Up Drills

53. The opening up drills on the B2 Control Harness are as follows:-

- a. Ensure that both radio sets have been tested and tuned to the required frequencies.
- b. Ensure that both sets are connected to the J2 (ensure that the set with the IC is connected to the "A" set connector).
- c. Check the security of all junction boxes and control units.
- d. Check the security of all cables and ensure that they are in good condition (especially check that the earth braid on all leads are intact and not showing through the plastic coating).
- e. Connect the appropriate microphone and headsets (ensure that they have been previously tested).
- f. Check the security and operation of all switches and controls.
- g. If a "B" box is fitted, ensure that the screwdriver switch on the J2 is at 'REB' and the plastic cover is in place/replaced.
- h. Connect the Remote Handset and D10 cable to the "R" box.
- i. Carry out the TESTS.

Tests

54. The tests on the B2 Control Harness require that the sets be put to "send" at various stages, therefore no tests should be carried out during periods of Electronic or Radio Silence. The tests on the B2 Control Harness are as follows:-

Tests	Result	Fault	Action
a. <u>J2</u> If the harness includes "B" box then the 'NORMAL REB' screwdriver controlled switch should be turned to "REB". If no "B" box is fitted then switch must be at "NORMAL.			

2 - 15/. Turn

RESTRICTED



RESTRICTED

2 - 15

Test	Result	Fault	Action
Turn left-hand switch to "ON".	Pilot lamp lights	No light	a. Check bulb b. Check fuse c. Report
b. <u>"C" Box</u>			
Connect headset. Operate call switch	Buzz heard	No buzz	Report
Select "I" and speak. (This test does not apply to simple B47 set installations unless they are fitted with an "I" box).	Sidetone heard	No sidetone	a. Change microphone b. Report
Select "B". Vary gain control.	Set noise heard and volume varies	a. No noise b. No variation	Report Report
Press press-to-talk switch and speak	Sidetone heard and set sends	No sidetone and/or set does not send	Report
On two set installations only select "A".	Set noise heard	No noise	Report
Press press-to-talk switch and speak.	Sidetone heard and set sends	No sidetone and/or set does not send	Report
c. <u>"D" Box</u>			
Connect headset. Operate "D" box call switch.	Buzz heard	No buzz	Report
Select "I". Press press-to-talk switch and speak.	Sidetone heard	No sidetone	a. Change microphone b. Report
Select "B". Vary gain control.	Set noise heard and volume varies	a. No set noise b. No variation	Report Report
On two set installations only select "A".	Set noise heard	No noise	Report

2 - 16/. Connect

RESTRICTED

RESTRICTED

2 - 16

	Test	Result	Fault	Action
d.	<u>No. 7 Microphone</u> Connect commanders headset to J2 or "G" box. Select "B" and vary gain control.	Set noise heard and volume varies	No set noise and/or no variation of volume	a. Change microphone b. Report
	Press press-to-talk switch and speak into microphone.	Sidetone heard and set sends	No sidetone and/or set does not send	a. Change microphone b. Report
	On two set installations only - Select "A".	Set noise heard	No noise	Report
	Press press-to-talk switch and speak into microphone.	Set noise heard	No noise	Report
	Switch to "I". Press press-to-talk switch and speak into microphone. (This does not apply to single B47 set installations unless they are fitted with an "I" box).	Sidetone heard	No sidetone	Report
	Switch to CALL.	Buzz heard	No buzz	Report
e.	<u>"R" Box</u> Connect headset. Set bottom left-hand switch to NORMAL. Turn top left-hand switch to CALL.	Buzz heard	No buzz	Report
	Turn top left-hand switch to "I" and speak into microphone. (This test does not apply to single B47 set installations unless they are fitted with an "I" box).	Sidetone heard	No sidetone	a. Change microphone b. Report
	Turn top left-hand switch to "B" and vary gain control	Set noise heard and volume varies	No noise and/or no variation	Report

RESTRICTED

2 - 17/. Press

RESTRICTED

2 - 17

Test	Result	Fault	Action
Press press-to-talk switch and speak.	Sidetone heard and set sends	No sidetone and/or set does not send	Report
Turn top left-hand switch to "A".	Set noise heard	No noise	Report
Press press-to-talk switch and speak.	Sidetone heard and set sends	No sidetone and/or set does not send	Report
Turn bottom left-hand switch to REMOTE. Turn bottom right-hand switch to "A".	"A" set noise heard in remote handset	No set noise heard	a. Change handset. b. Check cable c. Report
Turn bottom right-hand switch to "B".	"B" set noise heard in remote handset	No set noise heard	Report
Press press-to-talk switch on remote handset and speak.	Sidetone heard and "B" set goes to send	No sidetone and/or set does not send	a. Change handset b. Report
Press call button remote handset.	Buzz heard on headset connected to "R" Box. (Note the buzz is faint and set noise may drown it).	No buzz heard	a. Change handset b. Report
<u>Note:</u> Ensure bottom left-hand switch on "R" box is returned to NORMAL after completion of tests.			
f. <u>"B" Box Used For Auto-Rebroadcast</u> Switch all sets to NOISE OFF. Listen in operators headset connected to "R" box. Turn switch on "B" box to AUTO. Turn top left-hand switch on "R" box to "B". Turn up "A" set squelch and then reduce.	Noise heard and "B" set sends when squelch turned up	No noise or send  "B" set continues to	Report

RESTRICTED

2 - 18/. send

RESTRICTED

2 - 18

Test	Result	Fault	Action
		send when squelch turned down	a. Change "B" set frequency to at least 8 mhz from "A" set frequency but NOT a multiple of 6. b. Report
Turn top left-hand switch on "R" box to "A". Turn up "B" set squelch and then reduce.	Noise heard and "A" set sends when squelch turned up	No noise or send	Report
		"A" set continues to send when squelch turned down	Report
Turn switch on "B" box to "BREAK-IN". Turn top left-hand switch on "R" box to "A" or "B" (BUT NOT IC). Press press-to-talk switch and speak.	Sidetone heard and both sets go to send	No sidetone and/or sets do not go to send	Report
<u>Note:</u> Ensure switch on "B" is returned to NORMAL position after completion of test.			
g. "B" Box Used For Manual <u>Rebroadcast</u>			
Turn switch on "B" box to A - B.	"B" set sends	No send	Report
Turn switch on "B" box to B - A.	"A" set sends	No send	Report
Turn switch on "B" box to "BREAK-IN" Turn top left-hand switch on "R" box to "A" or "B" (BUT NOT IC). Press press-to-talk switch and speak.	Sidetone heard and both sets go to send	No sidetone and/or sets do not go to send	Report

RESTRICTED

2 - 19/. Connect

RESTRICTED

2 - 19

Test	Result	Fault	Action
<p>h. <u>"T" Box</u> Connect headset and switch the appropriate control unit to "A". Press the press-to-talk switch and speak.</p>	Sidetone heard and set sends	No sidetone and set does not send	Report
<p>i. <u>9.14 Metre Extension Leads</u> Connect to required control unit and connect the appropriate microphone. Select "A" and speak into the microphone.</p>	Sidetone heard and set sends	No sidetone and set does not go to send	Report

Closing Down Drills

55. The Closing Down Drills on the B2 Control Harness are as follows:-

- a. Switch the CN/OFF switch on the J2 to OFF.
- b. Remove and stow all microphones (if closing down for a long period).
- c. Check the condition of all junction boxes, control units and replace/report if necessary.
- d. Clean and dry all equipment.
- e. Check the condition and stowage of all spares.

Note:

Ensure that both of the radio sets are switched off prior to switching off the harness.

RESTRICTED

2 - 20/. (illus)

RESTRICTED

2 - 20

TYPICAL B2 HARNESS CONFIGURATION

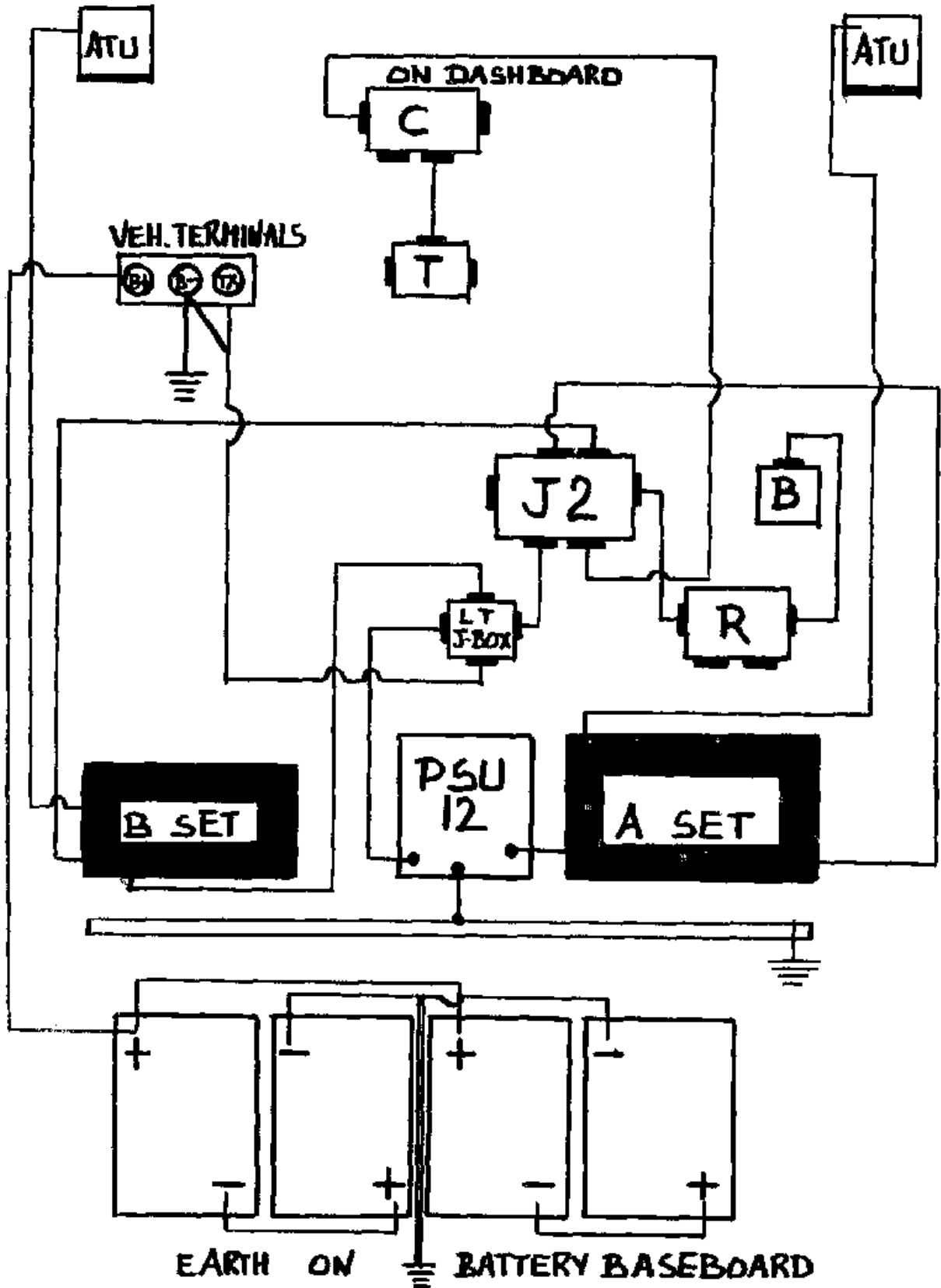

Figure 22

RESTRICTED

CHAPTER 3 - CONTROL HARNESS TYPE "A"

General

56. The Control Harness Type "A", comprising of a system of control units and junction boxes, is primarily intended for use in Armoured Fighting Vehicles. In the RAAC, it is used in the Centurion Main Battle Tank.

"A" Harness Types

57. The "A" Harness is used in the following configurations:-
- a. The "A2". Controls two radio sets (A and C), and is used in tanks other than Command vehicles. (Tank Troops).
  - b. The "A3". Controls three radio sets (A, B and C) and is used in the Command Tanks.

Note:

The "A2" and "A3" control harnesses are, except for the number of radio sets they control, identical. It is a simple matter to convert the one type of harness to the other by adding or removing one radio set, therefore, this chapter will deal almost entirely with the "A3" Control Harness configuration. (See figure 39 for the locations of the radio sets, antenna tuning units and antenna bases in the Centurion MBT).

Facilities

58. The facilities provided by the A3 Control Harness are as follows:-
- a. Control of three sets. Enables the crew members to receive and transmit over any of the three sets in the installation.
  - b. Normal Intercommunication (IC). Provided by an IC amplifier in the "A" set (therefore, the "A" set must be an RS C42). This enables the individual crew members to speak to each other within the vehicle or on the remote circuit and telephone.
  - c. Emergency Intercommunication. Enables the commander to communicate with the crew (one way), in the event of a harness failure.
  - d. Crash Intercommunication. Enables the commander to speak to the crew on the IC, regardless of the position selected on the crews control units.
  - e. Call Buzzer. Enables the crew members to attract each others attention. (Commander does not have a call facility).
  - f. Remote Control. Enables the facilities of the harness to be controlled remotely, via a handset connected to the harness by wire. The maximum length of wire that can be used is 1,000 metres. However, the Remote Cable Drum mounted on the vehicle is restricted, because of size, to 184 metres (600 ft).

RESTRICTED

3 - 2

- g. Infantry-Tank Telephone. Fitted externally and enables infantrymen to communicate with the commander on the IC. (The rest of the crew can also communicate).
- h. Commanders No. 5 Microphone. Enables the commander to select and monitor the sets and IC as required. (In conjunction with a CU34).
- i. Local Automatic Rebroadcast. A means of retransmitting a signal received on one frequency, via a transmitter on a different frequency. Both sets are contained "locally" in the one harness. Both sets must be VHF with the same types of squelch circuits.
- j. Local Manual Rebroadcast. A means of retransmitting a signal received on one frequency, via a transmitter on a different frequency. Takes place between two radio sets with dissimilar squelch circuits and one set is forced to "send" by a switch in the harness.
- k. Voltage Control Relay. Controls the input voltages to the sets. Should the voltage to the radios vary, the VCR will adjust the input to ensure that the sets receive the correct operating voltage. (See Chapter 1, para 22 for a detailed description of the Voltage Control Relay).
- l. Break-In. Enables the crew members to transmit over the two sets involved in the rebroadcast system (either automatic or manual).

Radio Sets used in the "A3" Harness

59. The three radio sets used in the "A3" Harness are as follows:-
- a. "A" Set. An RS C42. Used for the squadron frequency.
  - b. "B" Set. An RS C42. Used for the Rear Link frequency.
  - c. "C" Set. An RS B47. Used for the Tank Supporting Arms frequency.

Power Supply

60. The voltage required to operate the harness is 24 volts d.c. (direct current), and the harness uses approximately 0.6 amperes. Power is derived from four 6 volt - 150 ampere-hour-capacity secondary cell batteries, connected in SERIES. These batteries are located under the floor of the tank, to the rear of the 20 round ammunition bin, (See figure 23).

3 - 3/. Each

RESTRICTED



RESTRICTED

3 - 3

BATTERY CIRCUIT

Pl. VI

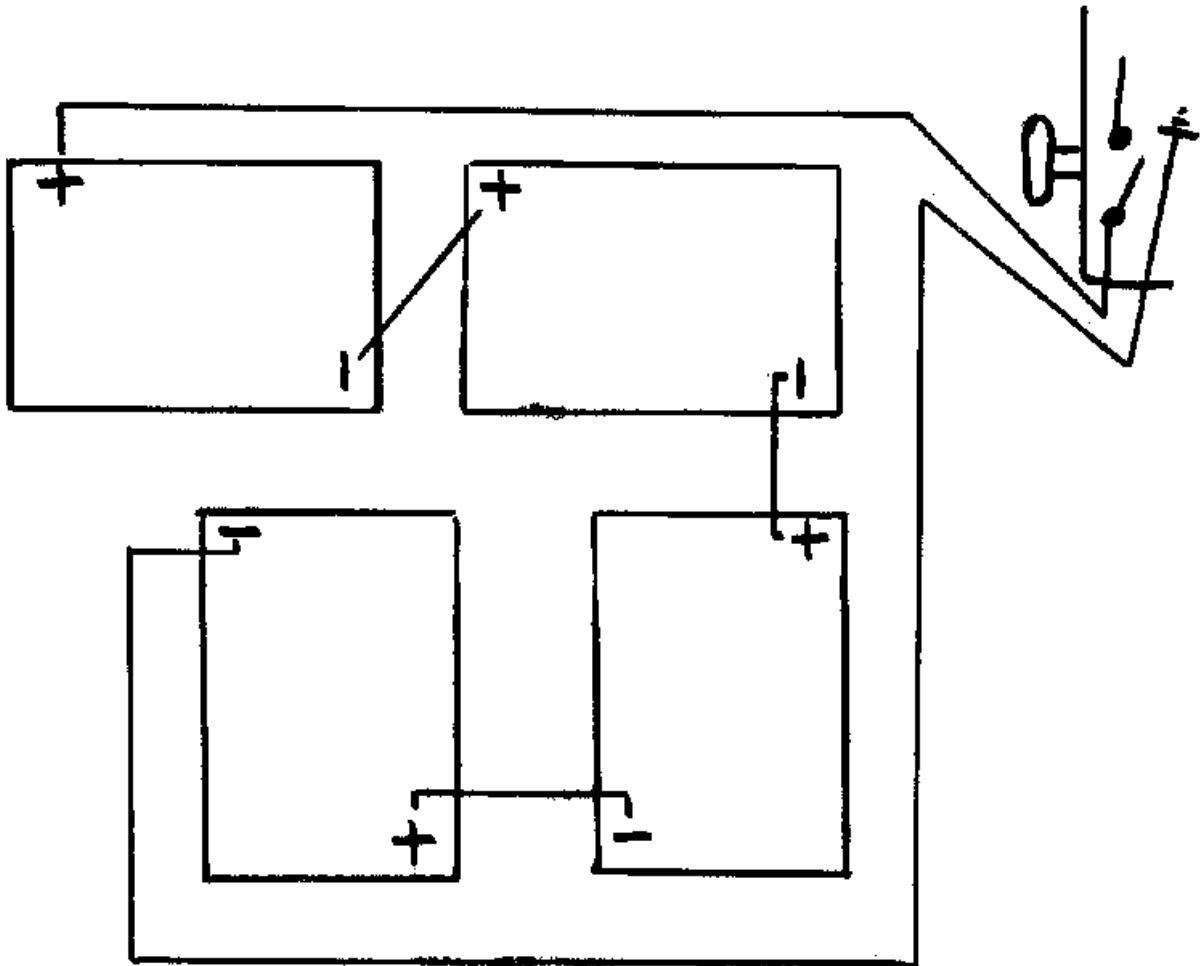

Pl. VI

Individual Component Construction

61. Each control unit and junction box is of similar cast construction, although the sizes and shapes vary according to the function of the unit. Each box is hermetically sealed to render it moisture and dust proof, and is mounted on a flexible base by means of which it is secured in a convenient position in the vehicle. Each unit is clearly marked with the designation by which it is known. All plugs and sockets are protected by screw on plastic covers when the connections are not in use. All control units are fitted with a raised flange to protect the switches and controls.

RESTRICTED

3 - 4/. The JD9

RESTRICTED

3 - 4

JUNCTION DISTRIBUTION NO. 9

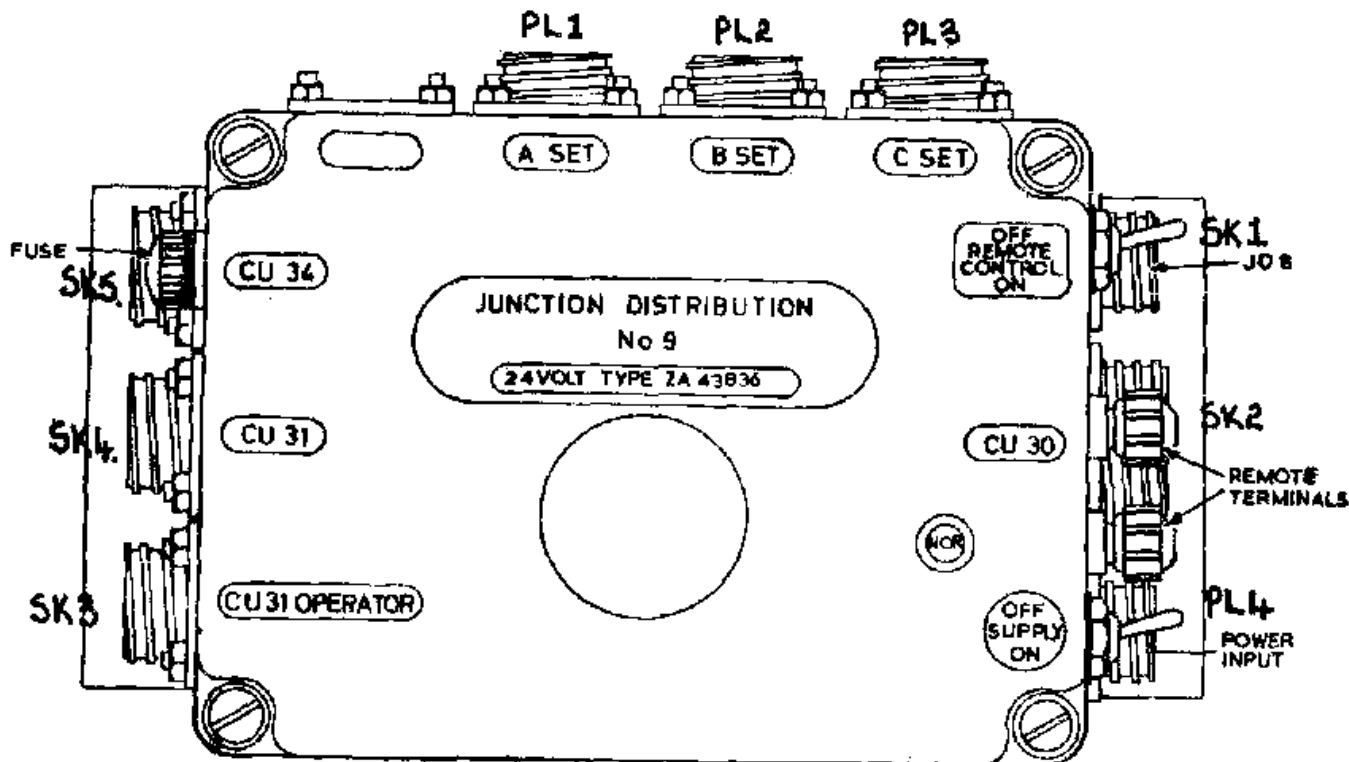

Figure 24

Junction Distribution No. 9 (JD9) (See figure 24)

62. The JD 9 is the focal point of the A3 harness. All components of the harness are either directly or indirectly connected to the JD9. It is the central distribution unit and contains relays and rotary switches which are actuated by the operation of switches on the individual control units. Electromagnetically operated "LEDEK" switches that are controlled by the switches on the CU31's are located inside the JD9. These "LEDEK" switches are protected by thermal cutouts (not by a fuse) which when connected, can be reset by depressing the "call" switch for approximately 10 seconds.

JD9 Connectors, Controls and Switches

63. The connectors, controls and switches on the JD9 are as follows:-

- a. PL1 Connector. 12 pins. To connect the "A" set. The IC is fed into the harness via this socket, therefore the "A" set must have IC.

3 - 5/. To connect

RESTRICTED

RESTRICTED

3 - 5

- b. PL2 Connector. 12 pins. To connect the "B" set.
- c. PL3 Connector. 12 pins. To connect the "C" set.
- d. SK1 Connector. 6 pins. Connects a screened cable to the drivers JDB (via the Rotary Base Junction). Inf/Tk Telephone and Tannoy circuits are fed into this socket via the 6 pin screened cable.
- e. SK2 Connector. 25 pins. To connect a rebroadcast control unit CU30.
- f. PL4 Connector. 2 pins. To connect a 24 volt power input to the harness.
- g. Remote Control Switch. An ON/OFF toggle switch to switch the remote control circuit on or off.
- h. Remote Control Terminals. Two screw in terminals to enable the remote cable to be connected to the harness. (It is also feasible to set up Remote Automatic Rebroadcast using components from a "B" harness).
- i. Power Switch. An ON/OFF toggle switch to switch the power to the harness on or off.
- j. SK3 Connector. 12 pins. To connect the Operators CU31. Set and IC selection for the remote circuit is controlled by the Ops CU31, therefore it must always be connected to this socket.
- k. SK4 Connector. 12 pins. To connect the gunners CU31.
- l. SK5 Connector. 12 pins. To connect the Commanders CU34.
- m. Fuse. A 2 amperes, short cartridge fuse to protect all circuits except the "LEDEX" switches. The symptoms of a blown fuse are as follows:-
  - (1) No call system.
  - (2) VCR selects low tap.
  - (3) No send on the Remote Handset.
  - (4) No set selection on No. 5 microphone.
  - (5) No Crash IC.
- n. NOR/REB Switch. An internally adjusted switch with a glass viewing window. When a CU30 is fitted, it must be at "REB", and when a CU30 is not fitted, at "NOR". The purpose of this switch is to stop crew members from interfering with rebroadcast when the switch on the CU30 is NOT at Break-In. This switch should not be touched by anyone except authorised personnel.

RESTRICTED

3 - 6/. Two control

RESTRICTED

3 - 6

CONTROL UNIT NO. 31

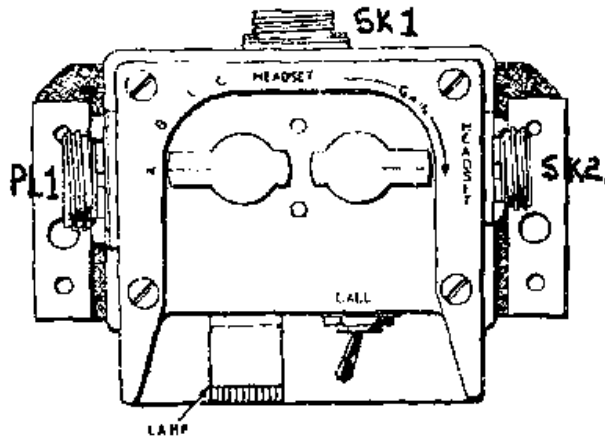

Figure 25

Control Unit No. 31

64. Two control units No. 31 are used in the A3 harness, one by the Operator, and one by the Gunner. Both units are identical. The connectors, switches and controls on the CU31 are as follows:-

- a. PL1 Connector. 12 pins. To connect the cable from the JD9.
- b. SK1 Connector. 6 pins. To connect either a 9.14 metre audio extension lead or crewmans No. 6 microphone.
- c. SK2 Connector. As for para b. above.
- d. Call Switch. A spring loaded toggle switch to operate the call buzzer. All crewmen connected to the harness will hear the call. Also a means of resetting the "LEDEX" switches.
- e. Low Tension Indicator Lamp. A "red" lamp, fitted with a dimmer shield and used to indicate that low tension power is present in the unit. The body of the lamp cover unscrews to enable the bulb to be changed. The bulb is a 12 volt - 22 watt screw in lamp. The lamp is connected in the circuit in such a manner that it is momentarily extinguished when the control unit selector switch is altered, and recommences to glow when the slave switch inside the JD9 has completed its movement to the selected position. The lamp will also flicker when the call buzzer is operated.

3 - 7/. Enables

RESTRICTED

RESTRICTED

3 - 7

- f. Selector Switch. Enables the user to select the required operating position. The four positions are as follows:-
- (1) "A". Enables the user to transmit and receive on the "A" set.
  - (2) "B". Enables the user to transmit and receive on the "B" set. This position is not used in an A2 harness.
  - (3) "I". Enables the user to transmit and receive on the intercommunication.
  - (4) "C". Enables the user to transmit and receive on the "C" set.
- g. Gain Control. Adjusts the volume in the microphone receivers of the No. 6 microphones connected to the unit.

JUNCTION DISTRIBUTION

NO. 8 (Drivers)

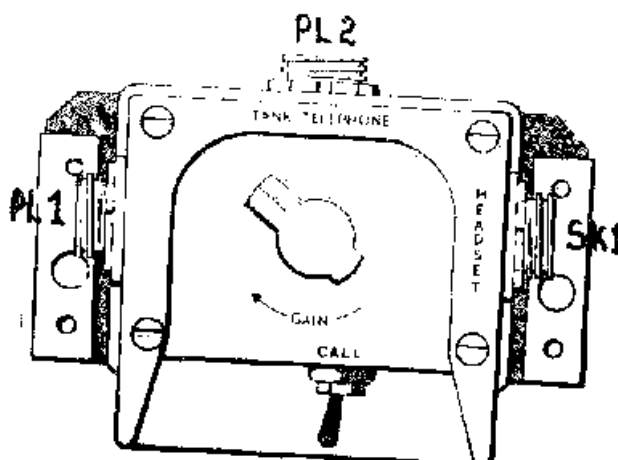

Figure 26

Junction Distribution No. 8

65. This unit, used by the driver, has no selector switch, the facilities being limited to listening and speaking on the intercommunication system. The connectors and controls on the JD8 are as follows:-

- a. PL1 Connector. 6 pins. To connect the JD8 to the JD9, via the 6 pin screened cable.

RESTRICTED

3 - 8/. No longer

RESTRICTED

3 - 8

- b. PL2 Connector. No longer used. Previously used to feed the Inf/Tk telephone circuit into the harness. If a microphone is accidentally connected to this socket and the press to talk switch is pressed, the call system will operate. (See figure 34 for the modification to the telephone wiring). 6 pins.
- c. SK1 Connector. 6 pins. To connect either a 9.14 metre audio extension lead or a No. 6 microphone.
- d. Call Switch. A spring loaded toggle switch to operate the call buzzer.
- e. Gain Control. Adjusts the volume in the receivers of the No. 6 microphone.

CONTROL UNIT NO. 34

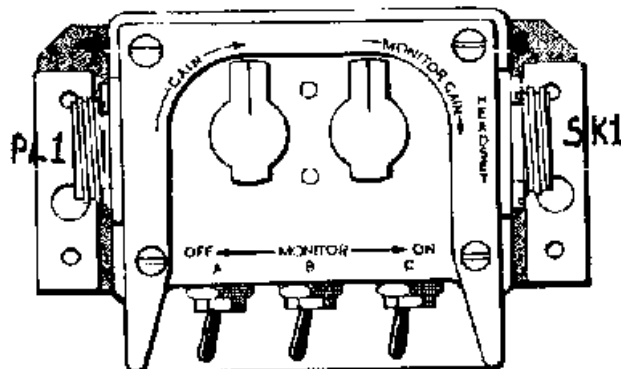

Figure 27

Control Unit No. 34

66. The Control Unit No. 34 is used by the commander. This unit, in conjunction with the No. 5 microphone, enables the commander to monitor all sets and select the required set for transmitting. The connectors, switches and controls on the CU34 are as follows:-

- a. PL1 Connector. 12 pins. To connect the CU34 to the JD9 via a 12 pin cable.
- b. SK1 Connector. 12 pins. To connect a No. 5 microphone and/or a 9.14 metre audio extension lead.

3 - 9/. Three

RESTRICTED

- c. Monitor Switches. Three monitor ON/OFF switches are located on the under side of the unit to enable the commander to select the radio sets to be monitored. Each monitor switch is designated by either the letter A, B or C to indicate the radio set it controls. As an example, with the monitor switch "A" ON, the commander will hear any signals on the "A" set, regardless of where his microphone selector switch is positioned. With all three switches ON, he will hear all sets, regardless of the position of the microphone selector switch.

Note:

If the commander has his CU34 monitor switches ON, the gunner and operator will also be able to monitor. (Except when the No. 5 microphone monitor ON/OFF switch is OFF).

- d. Gain Control. With the No. 5 microphone or the CU34 monitor switches OFF, this gain control adjusts the volume in both of the commanders earphones. With the monitors ON, this gain control effects the LEFT earphone only. With "A" selected on the microphone, the "A" set will be heard in the LEFT earphone only and the gain control will only effect the volume of the "A" set. The same will apply for any of the other radio sets selected on the microphone.
- e. Monitor Gain. With the monitor switches to the OFF position, this control is disconnected. With the monitors ON, it controls the volume in the RIGHT earphone and effects the sets that are being monitored. For example, if all monitor switches were ON and "B" was selected on the No. 5 microphone, the "A" and "C" sets would be heard in the Right earphone and the monitor gain would control the volume of these sets. The "B" set would be heard in the LEFT earphone and its volume would be controlled by the GAIN control. The purpose of the Gain and Monitor Gain controls, is to enable the commander to receive the "selected" radio set at a greater volume than the "monitored" radio set or sets.

Commanders No. 5 Microphone

67. This is the microphone and receiver headgear assembly that is connected to the CU34. It is designated Microphone head SI (standard insert) No. 5 and neckband snatch harness, and Receivers headgear SI double No. 1A. Separate connectors from the microphone and receivers are joined at a small junction box (breastplate) which normally hangs from the users neck on a web strap. A snatch plug connects the receiver phones to the junction box, which is itself attached to the webbing neckband harness by means of stud fasteners. Snatch plug and stud fasteners will easily part if given a sharp pull, and thus in an emergency, the wearer can quickly free himself

RESTRICTED

3 - 10

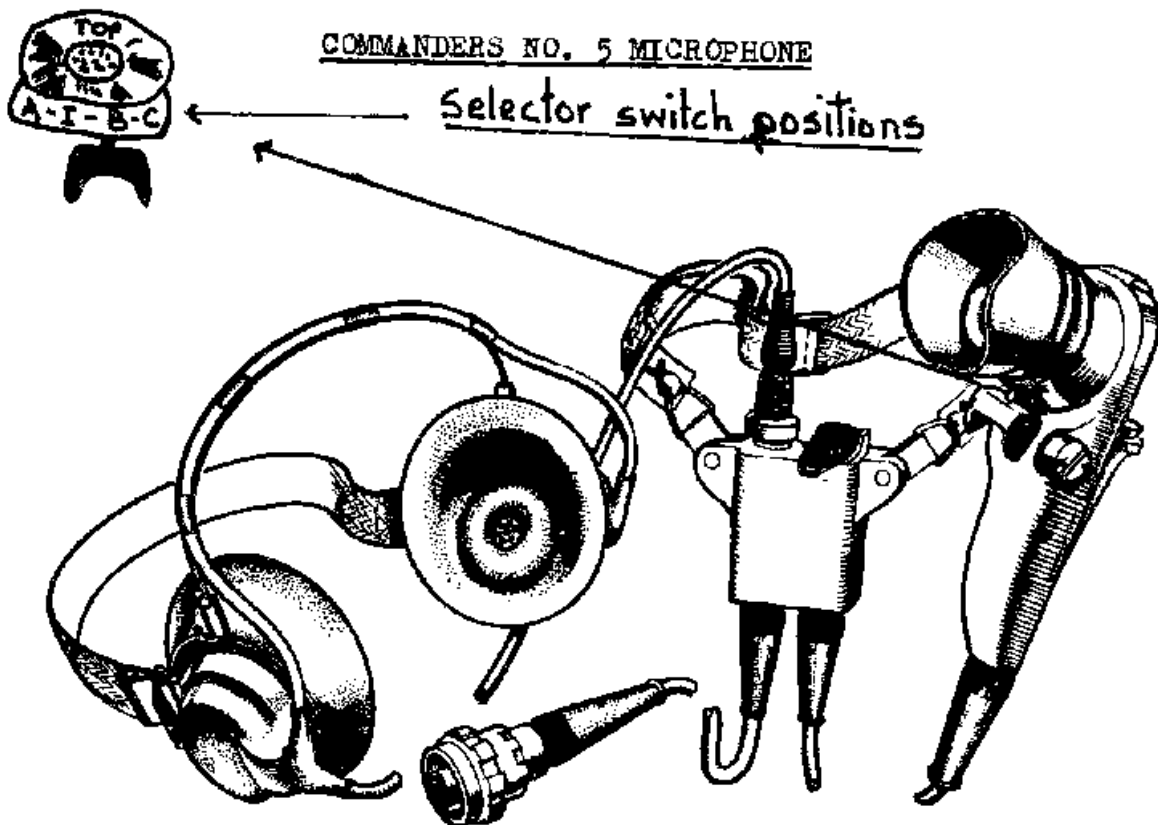

Figure 28

from the assembly. A press-to-talk switch on the microphone performs the send-receive switching, this switch being readily manipulated by either hand. The audio lead is fitted with a 12 pin plug for connection to the CU34 or a 9.14 metre audio extension lead. A two pin socket is located on the side of the microphone body to enable a respirator with a microphone element to be connected. The receiver headgear is adjustable to suit the size and shape of the users head. A monitor ON/OFF switch is fitted to the top of the junction box to enable the commander to disconnect the monitor circuits from his earphones. If for example, the commander was receiving an important transmission on the "A" set, and the monitored (B and C sets) were drowning out the message, he can select "A" on his microphone and switch the breastplate monitor OFF and he would then only hear the "A" set. This saves him the trouble of having to waste time switching the monitor ON/OFF switches on the CU34 to OFF. A selector switch is fitted below the microphone to enable the commander to select the required position. These positions are:-

- a. "A". Enables the commander to transmit over the "A" set.

3 - 11/. In this

RESTRICTED



RESTRICTED

3 - 11

- b. "I". In this position, the commander has a "live-microphone" and can talk over the IC without having to press his press-to-talk switch. All crewmen on the IC will hear him. With "I" selected and the press-to-talk switch pressed, the commander brings into operation "Crash IC". This enables him to speak to all the crew on the IC, regardless of the positions of their switches on the control units (CU31). All crewmen can answer without switching to "I" as long as the commander has his press-to-talk switch depressed. Crash IC, jams the whole harness on IC.
- c. "B". Enables the commander to transmit on the "B" set.
- d. "C". Enables the commander to transmit on the "C" set.

Note:

The commander will not hear the "IC" unless he has selected "I" on his microphone. With "I" selected he will hear the IC in his LEFT earphone, and the monitored sets in his RIGHT earphone. With all monitors OFF, the set or IC selected on the microphone, will be heard in both ears.

CONTROL UNIT NO. 30

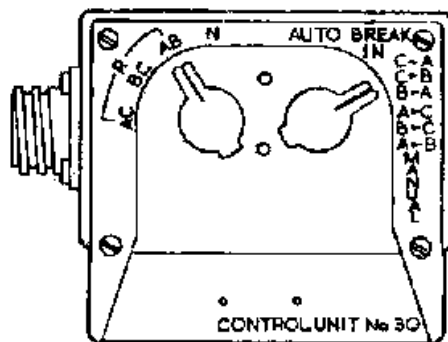

Position of switches

Figure 29

RESTRICTED

RESTRICTED

3 - 12

Control Unit No. 30

68. The Control Unit No. 30 controls and Local Automatic and Local Manual Rebroadcast facilities. It has only one connector, this being a 25 pin socket to connect it to the JD9 via a 25 pin cable. Two switches are fitted to the face of the unit, the left-hand switch for selecting the radio sets to be used in the rebroadcast, and the right-hand switch for selecting the mode of operation. This unit is only used by the station that is setting up the rebroadcast system. All other stations leave their CU30s at NORMAL and AUTO.

CU30 Switches

69. The switches and their positions are as follows:-

- a. Left-hand Switch. This switch selects the radio set combination for the rebroadcast system. The switch positions are as follows:-
  - (1) "N" - NORMAL. All normal facilities can be used and rebroadcast is disconnected.
  - (2) "AB". The "A" and "B" sets have been selected for rebroadcasting.
  - (3) "BC". The "B" and "C" sets have been selected for rebroadcasting. It must be remembered that the "C" set, an RS E47, does not have the range of an RS C42.
  - (4) "AC". The "A" and "C" sets have been selected for rebroadcasting. With the A2 Control Harness, this is the only combination that can be used.
- b. Right-hand Switch. This switch selects the type of rebroadcast to be used and enables the user to "Break-In" and force a radio set to transmit. The switch positions are as follows:-
  - (1) AUTO - Automatic. Selects Local Automatic Rebroadcast. In this position, distant stations can communicate on the two frequencies. This can only take place between sets with similar squelch circuits. Frequencies must be no closer together than 3 mhz apart and not in multiples of 6 mhz.
  - (2) BREAK-IN. Enables the user to transmit over both the radio sets selected by the Left-hand switch (i.e., "AC"). If accidentally left in this position, rebroadcasting between the two frequencies will be disrupted. Used for both automatic and manual rebroadcast.

3 - 13/. This one

RESTRICTED

RESTRICTED

3 - 13

(3) C - A

C - B - This one switch position has three combinations. It is only used for Manual rebroadcast. Depending on the combination selected by the left-hand switch, the first named set will be receiving a signal and the second named set will be manually forced to transmit. (ie., With "AC" selected on the left-hand switch, the "C" set will be receiving and the "A" set will be forced to "send"). The second named set will remain at send until the switch is moved. This position is only used when rebroadcasting between sets with dissimilar squelch circuits.

(4) A - C

B - C - This one switch position has three combinations also. It is only used for Manual rebroadcast. As with the other combinations (para (3) above), the first named set will be receiving and the second named set will be manually forced to transmit (ie., with "BC" selected on the left-hand switch, the "B" set will be receiving and the "C" set will be forced to "send"). The second named set will remain at send until the switch is moved. As with para (3) above, this position is only used when rebroadcasting between sets with dissimilar squelch circuits.

Note:

When using Manual Rebroadcast, the right-hand switch is put to BREAK-IN so that the rebroadcast operator can determine which of his two sets is receiving. When he has determined which set has commenced to receive, he will immediately switch from BREAK-IN to one of the switch positions mentioned in paras (3) and (4) above to force the second set to send. The operator will adjust the switch between these two settings so that signals can alternately be transmitted between the two sets. When an "OUT" has been given, the rebroadcast operator will return the right-hand switch to BREAK-IN and wait for the next transmission, to determine which set to force to send. WHEN REBROADCAST IS NO LONGER REQUIRED, BOTH SWITCHES MUST BE RETURNED TO "N" AND "AUTO".

Telephone, Hand, Remote Control No. 1

70. The Telephone, Hand, Remote Control is a lightweight, green plastic handset. It is designed to be used remotely, from a Control Harness that it is connected to, by two wire cables (D10). It is fitted with one receiver element and one microphone element. In between these two elements, on the handgrip, is a press-to-talk bar. Below the microphone element, two remote terminals are provided to enable the D10 cable to be connected to the handset. The cable is inserted into each of the terminals, and the outer sleeves are screwed in to retain the cable. Serrated teeth bite into the cable to ensure a

RESTRICTED

3 - 14/. good

RESTRICTED

3 - 14

TELEPHONE, HAND, REMOTE CONTROL NO. 1

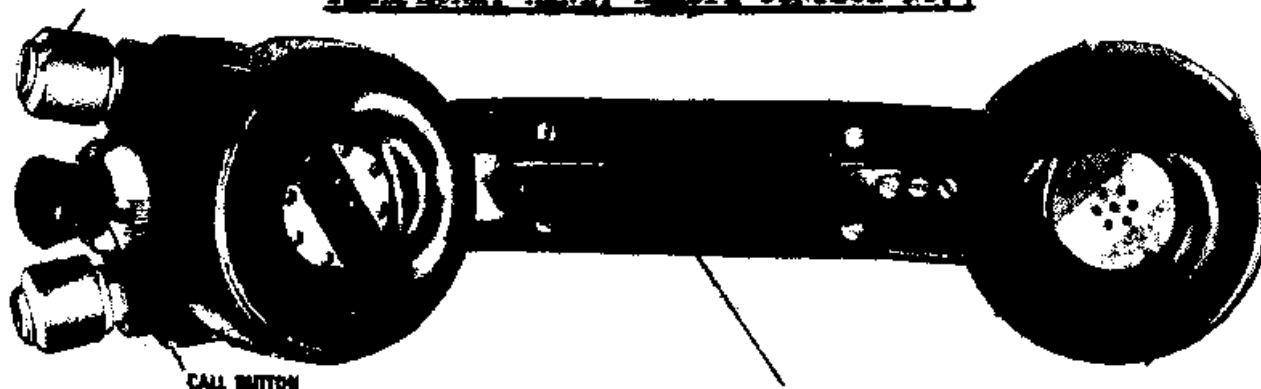

Figure 30

good contact. Between the remote terminals, is a CALL button. This enables the remote operator to attract the attention of the local operator inside the tank. The operators CU31 controls the remote handset in so much as the operators CU31 selector switch will determine which set/IC the handset will be on. (ie., if the CU31 was at "A", the remote handset would also be on "A"). Polarity is not essential when connecting the remote handset. The handset can be used to a maximum distance of 1000 metres away from the tank, however, it is restricted to a maximum distance of approximately 184 metres as the remote cable drum can only hold this amount of D10 cable.

REMOTE CABLE DRUM (LOCATION)

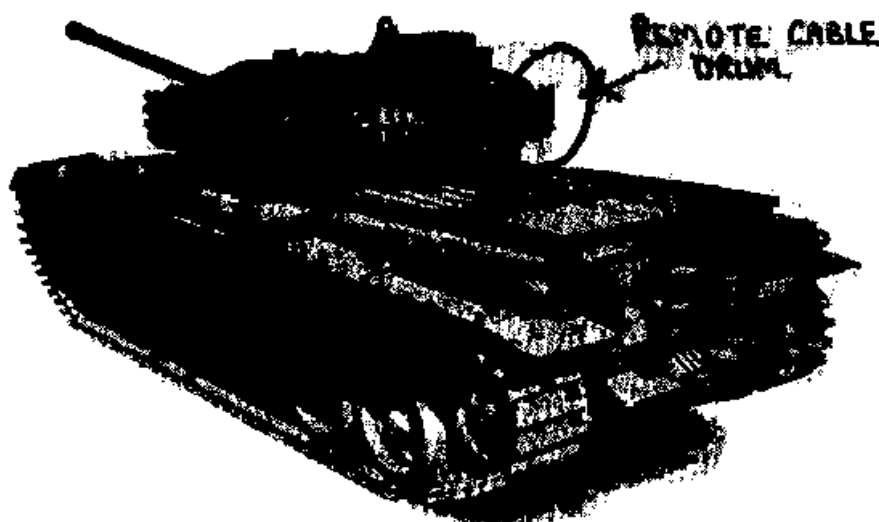

Figure 31

3 - 15/. (illus)

RESTRICTED

RESTRICTED

3 - 15

REMOTE CABLE DRUM

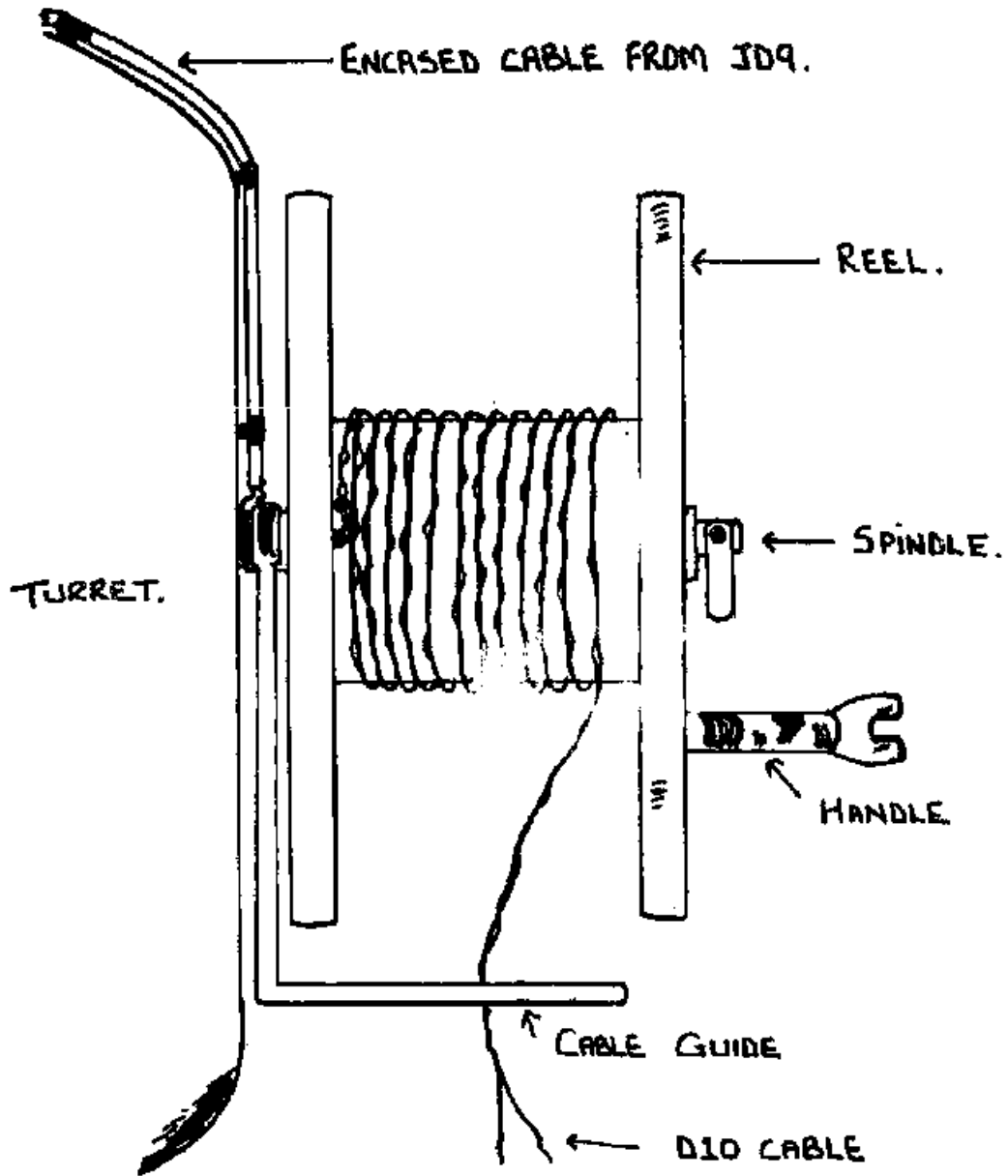

Figure 32

3 - 16/. The remote

RESTRICTED

RESTRICTED

3 - 16

Remote Cable Drum (See figures 31 and 32)

71. The Remote Cable Drum is located on the right rear of the turret bulge. It consists of a removeable cable reel, a spring loaded winding handle, a rotating cable guide, approximately 184 metres of D10 cable and a canvas cable cover. The cable from the remote terminals on the JD9 is clamped to the inside of the turret wall and is fed through an opening in the turret roof (right-hand rear). Externally, the cable is encased in rigid conduit. The cable is connected to the cable drum spindle via spring-loaded contacts to enable the drum to rotate without damage to the cable. The drum is fitted with a spring-loaded handle which can be folded inwards when not in use, and then acts as a lock, to stop the drum from rotating. A wide strap is fitted over the cable spool to keep it in a clean condition when not in use. The cable can be quickly run out the required distance from the vehicle by one man. The Remote ON/OFF switch on the JD9, must be ON, and the operators CU31 selector switch to the required setting to enable the Remote circuit to be used,

INFANTRY/TANK TELEPHONE

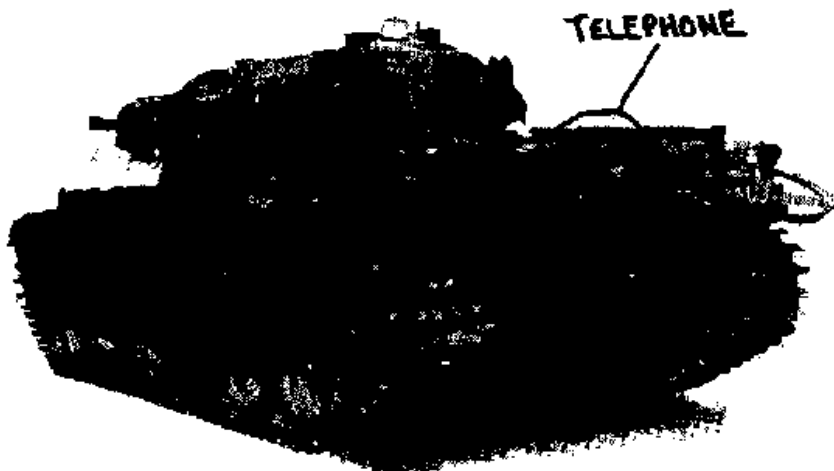

Figure 33

Infantry/Tank Telephone

72. The Infantry/Tank Telephone is designed to enable the Infantry to communicate with the tank crew without having to climb onto the vehicle. It is located on the left-hand rear of the vehicle in a rectangular steel casing. On the modified Centurion, with a rear fuel tank fitted, the Telephone is located on the left-hand side of the fuel tank. The top section of the Telephone housing is for the carriage of a first-aid kit that can be used by the Infantry if

RESTRICTED

3 - 17/. (illus)

RESTRICTED

3 - 17

INFANTRY/TANK TELEPHONE CIRCUIT

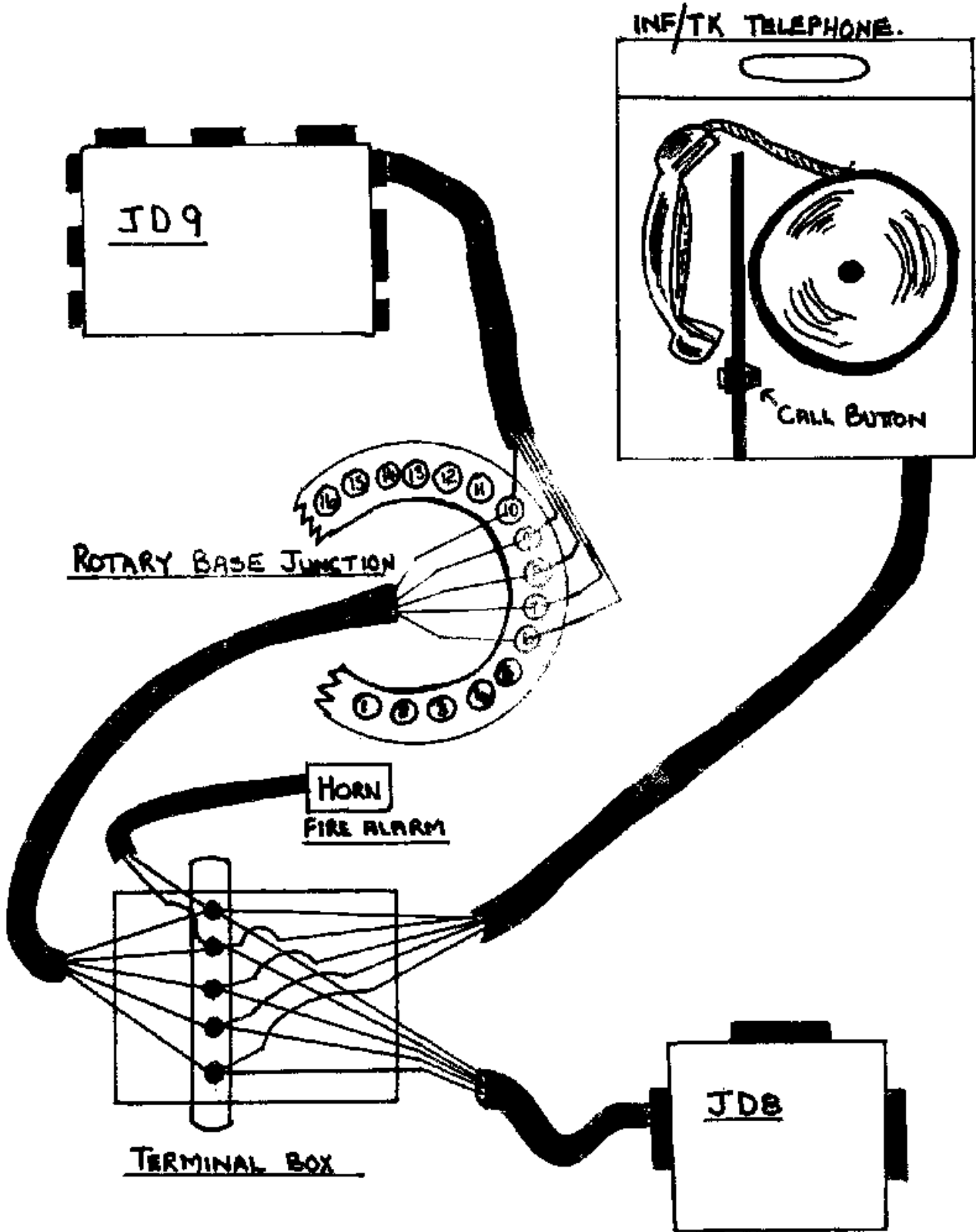

Figure 34

RESTRICTED

3 - 18/. needed

RESTRICTED

3 - 18

needed. A hinged access door is fitted to the lower left front of the casing to enable the user to remove the rubber handset from the housing. The handset is fitted with a press-to-talk bar which has to be depressed for transmit and receive. Approximately 3 metres (10 ft) of cable is wound onto a spring-loaded return drum, and when the handset is released it will return under its own power to the housing. A CALL button is located inside the handset recess (right-hand side), to attract the attention of the crew commander. The telephone works into the IC circuit via the drivers JD8. (See figure 34). All crew members connected to the harness will hear the telephone as long as they have "I" selected on their control units.

Emergency Crew Control (Tannoy)

73. The emergency IC system is powered by 24 volts d.c. from the battery balancer box, which is located on the right-hand turret wall (near the gunner's right shoulder). A transformer is located in the base of the battery balancer box, and into this is fitted the Tannoy (three pin plug). A single "speech" wire runs from the transformer to the No. 8 terminal in the Rotary Base Junction, and from there into the screened cable from the JD9 to the JD8. The Emergency Crew Control (Tannoy) is an alloy, grey painted, hand held microphone. It is fitted with an adjustable webbing neck strap and a press-to-talk switch. The commander uses the Tannoy when the IC system fails (therefore, it should be connected at all times - in cases of an emergency). The commander can talk to the driver and crew (if the gunner and operator are at "I"), but the crew cannot talk back to the commander. A Bridge fuse is located in the Battery Balancer Box to protect the Tannoy circuit (fuse 6). The Tannoy has approximately 1.5 metres (5 feet) of cable connected to it, and this terminates in a three pin female connector.

Fuses

74. Apart from the 2 ampere fuse in the JD9, there are three other fuses in the Centurion that directly concern the A3 Control Harness. These are:-

- a. Fuse No. 3. A Bridge fuse, located in the fuse compartment in the Battery Balancer Box. Protects the power circuit to the radio sets and harness. Should this fuse blow, the radio equipment would not get any power at all.
- b. Fuse No. 6. Located in the same place as fuse No. 3, and is of the same type. This fuse protects the Emergency IC circuit (Tannoy). Should this fuse blow, the Tannoy would not work.
- c. Fuse "H". Located in the drivers switchboard and is a Bridge fuse. This fuse protects power to the 24 volt Slip Ring in the Rotary Base Junction, in other words, all power to the turret. Should this fuse blow, no equipment in the turret would function.

3 - 19/. (illus)

RESTRICTED



RESTRICTED

3 - 19

EMERGENCY CREW CONTROL



Figure 35

RESTRICTED

3 - 20/. (illus)

TANNOY CIRCUIT

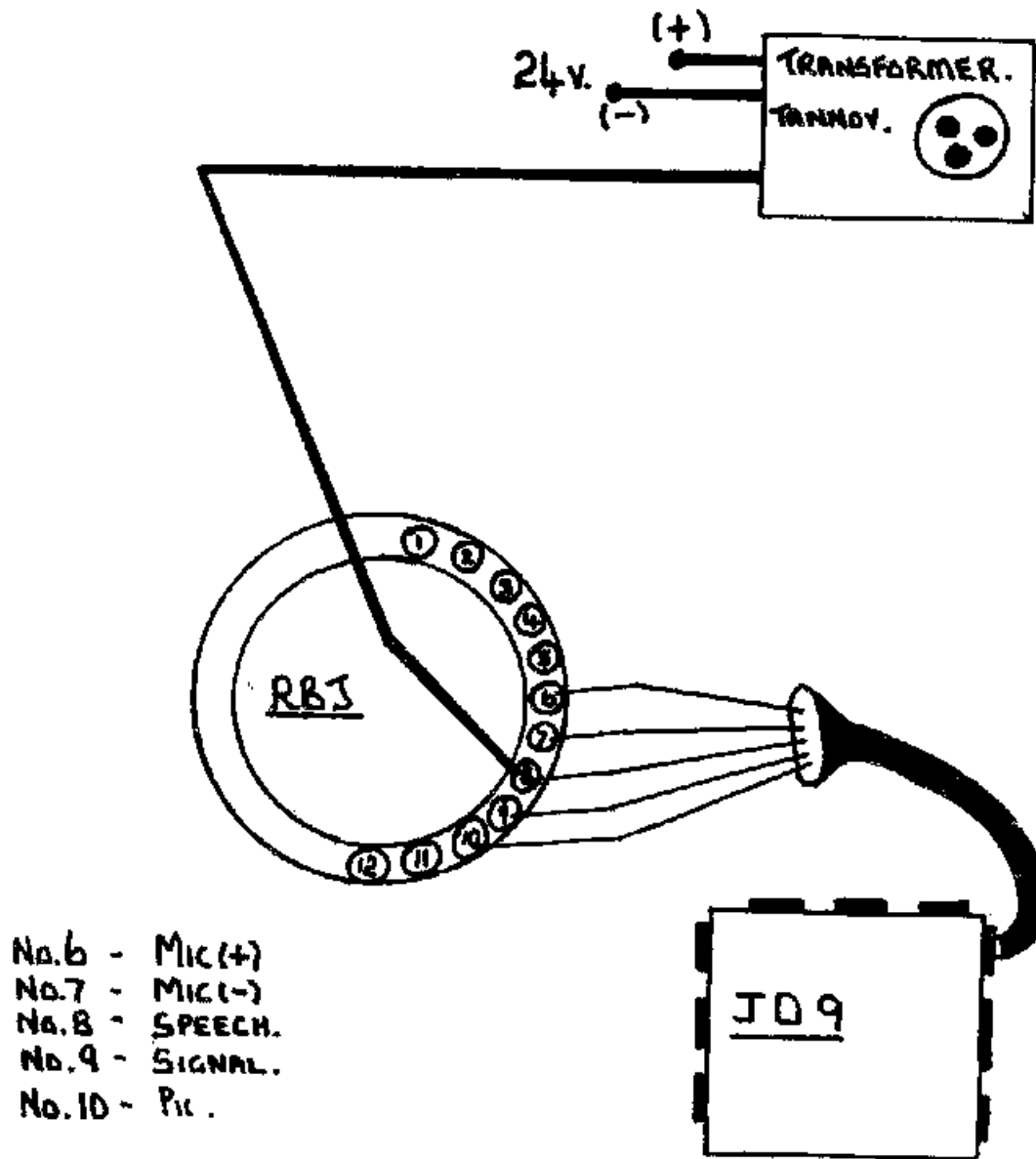

Figure 36

3 - 21/. The driver

RESTRICTED

RESTRICTED

3 - 21

BATTERY BALANCER BOX



Figure 37

Greens No. 6 Microphones

75. The driver, gunner and operator all use the No. 6 microphone. Refer to Chapter 1, para 13, figure 5 for a description.

12 and 6 Pin Audio Extension Leads No. 35 and No. 88

76. The 12 pin, No. 88 extension lead can be connected to the CU34, and the 6 pin? No. 35 extension can be connected to the CU31s and JD8. Refer to Chapter 1, paras 19 and 20 for a description of these extensions.

Note:

Only two audio extension leads can be connected together and used from a control unit. Any more than this will effect the efficiency of the reception and transmission facilities of the unit.

Operation of Remote Control Circuit

77. To use the Remote facilities, carry out the following:-
- a. Remove the canvas strap from the Remote Cable Drum and unlock the handle.
  - b. Feed the end of the D10 cable through the cable guide.

RESTRICTED

3 - 22/. Remove

RESTRICTED

3 - 22

- c. Remove approximately 12 millimetres ( $\frac{1}{2}$  inch) of plastic coating from the ends of the D10 cable and connect the remote handset (polarity not essential).
- d. Ensure the remote terminals on the JD9 are connected to the cable inside the turret.
- e. Switch the Remote ON/OFF switch on the JD9 to ON.
- f. Switch the operators CU31 to the required position. (Preferably "I" initially).
- g. Press the press-to-talk switch on the remote handset and speak into the microphone. If the local operator can hear you, select the required set on the Operators CU31 and run the cable out to the required location.
- h. To contact the local operator, press the call button. Upon hearing the call signal, the local operator will switch to "I" and you can then communicate.
- i. When finished with the remote facility, ensure that the cable drum is secure, handset removed and stowed, Remote ON/OFF switch if OFF and the canvas cover is placed on the cable drum.

Operation of the Inf/Tk Telephone

78. To use the Inf/Tk Telephone, carry out the following:-
- a. Open the hinged access door.
  - b. Remove the handset, and press the Call button twice.
  - c. Depress the press-to-talk bar and listen. When commander answers, keep the press-to-talk bar pressed for the duration of the conversation.
  - d. When finished, release the handset and allow it to return of its own accord.
  - e. Ensure the handset is fully home, then close the cover.

Note:

DO NOT pull the handset out too far as damage may result to the cord or spring-loaded cable drum.

Operation of Emergency IC

79. To use the Emergency Crew Control, carry out the following:-
- a. Plug the Tannoy into the Tannoy transformer.
  - b. Press the press-to-talk switch and speak into the microphone.

3 - 23/. If the

RESTRICTED

RESTRICTED

3 - 23

- c. If the driver cannot hear you, check the fuse in the Battery Balancer Box.

Operation of CU30 for Automatic Rebroadcast

80. To set up Local Automatic Rebroadcast, carry out the following:-

- a. Ensure that the two radio sets you are going to use have the required frequencies (no closer than 3 mhz apart and not in multiples of 6 mhz).
- b. Ensure that both squelch circuits are correctly adjusted.
- c. Ensure that the small window on the face of the JD 9 show "REB". (If not - report).
- d. Ensure that the operators CU31 is switched to one of the two sets being used.
- e. Switch the left-hand switch on the CU30 to "AB", "BC" or "AC", depending on the two sets you have selected for use.
- f. Switch the right-hand switch on the CU30 to BREAK-IN, and inform both "nets" that you have rebroadcast their nets.
- g. Switch the right-hand switch on the CU30 to AUTO (distant stations on the two frequencies can now communicate).
- h. To answer/originate a call, switch to break-in and transmit. On completion of the transmission, switch back to AUTO.

Note:

When rebroadcast is no longer required, ensure that both switches on the CU30, are at "N" and "AUTO".

Operation of CU30 for Manual Rebroadcast

81. To set up Local Manual Rebroadcast, carry out the following:-

- a. Ensure that the two radio sets you are going to use have the required frequencies (using sets with dissimilar squelch circuits).
- b. Ensure that the small window on the face of the JD9 shows "REB" (if not - report).
- c. Ensure that the operators CU31 is switched to one of the two sets being used.

3 - 24/. Switch the

RESTRICTED

RESTRICTED

3 - 24

- d. Switch the left-hand switch on the CU30 to "AB", "BC" or "AC", depending on the two sets you have selected for use.
- e. Switch the right-hand switch on the CU30 to BREAK-IN, and inform both "nets" that you have rebroadcast their nets.
- f. Leave the right-hand switch at BREAK-IN and listen for the first transmission to be made.
- g. Taking it that you are using the "A" and "C" sets for rebroadcasting, and the "A" set commences to receive, switch to A - C (next setting to the right of BREAK-IN). This will force the "C" set to send.
- h. If an answer is required to the transmission, switch to C - A (last setting on right-hand switch) and force the "A" set to send.
- i. Continue to alternate between the two settings until the call has finished, then switch back to BREAK-IN and wait for the next call.
- j. Simply remember, that if one of your sets commences to receive, force the other to "send".
- k. To answer/originate a call yourself, leave the switch at break-in and transmit.

Note:-

- a. The rebroadcast operator must leave the right-hand switch at BREAK-IN to determine which of his two sets has commenced to receive before switching.
- b. Ensure that both switches on the CU30 are at "N" and "AUTO" when rebroadcast is no longer required.

Operation of the CU34 and No. 5 Microphone

82. To use the CU34 in conjunction with the No. 5 microphone, carry out the following:-

- a. Connect the microphone to the CU34.
- b. Switch ON the required Monitor switches on the CU34.
- c. Switch ON the Monitor switch on the microphone breastplate.
- d. Select the required setting on the microphone selector switch (preferably "I").
- e. Adjust the volume of the set or IC selected on the microphone (using the GAIN control on the CU34 - adjusts the volume in the left earphone).

RESTRICTED

3 - 25/. (illus)

A3 CONTROL HARNESS

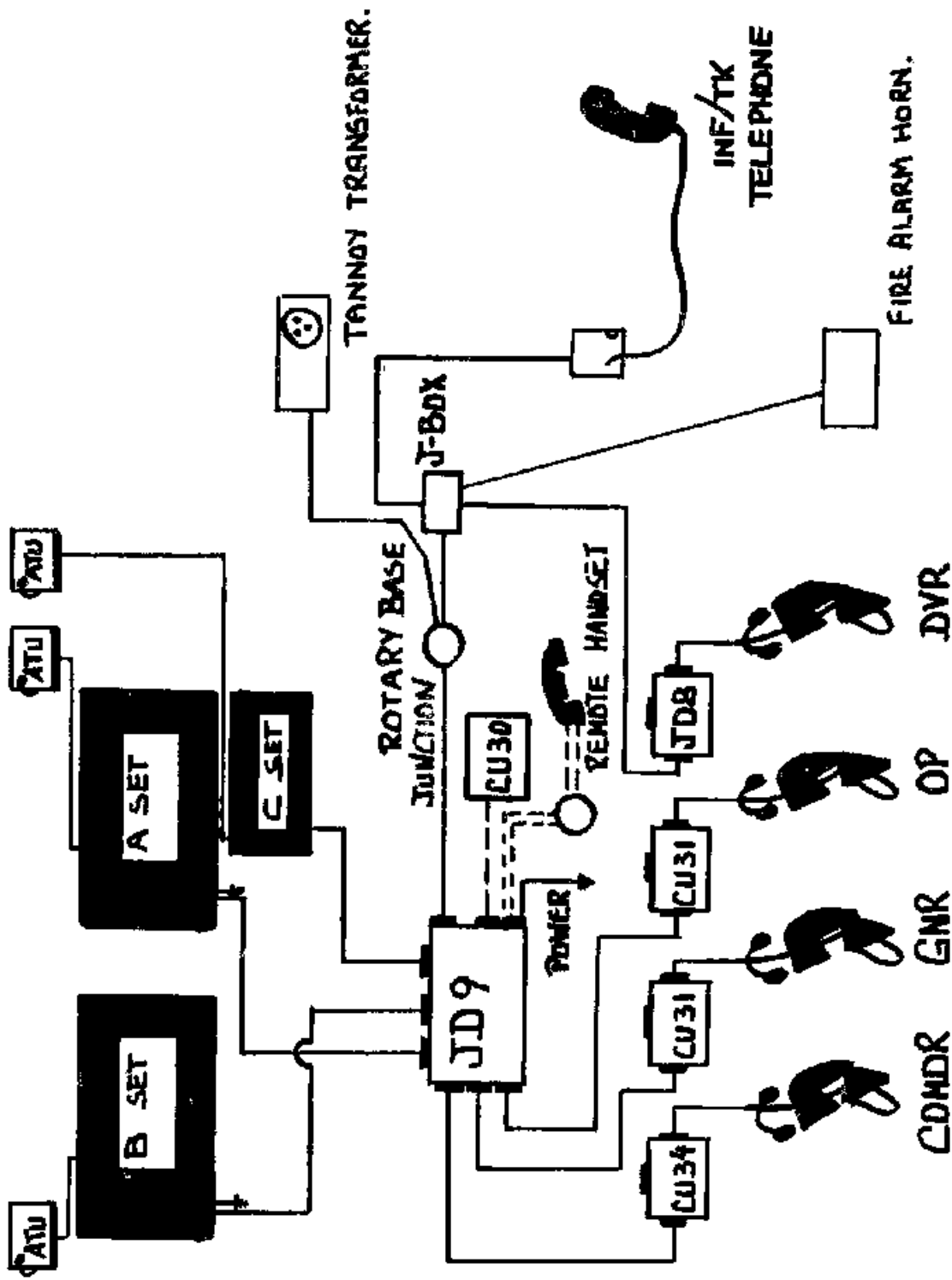

Figure 38

RESTRICTED

3 - 26

LOCATION OF A3 HARNESS COMPONENTS IN TANK

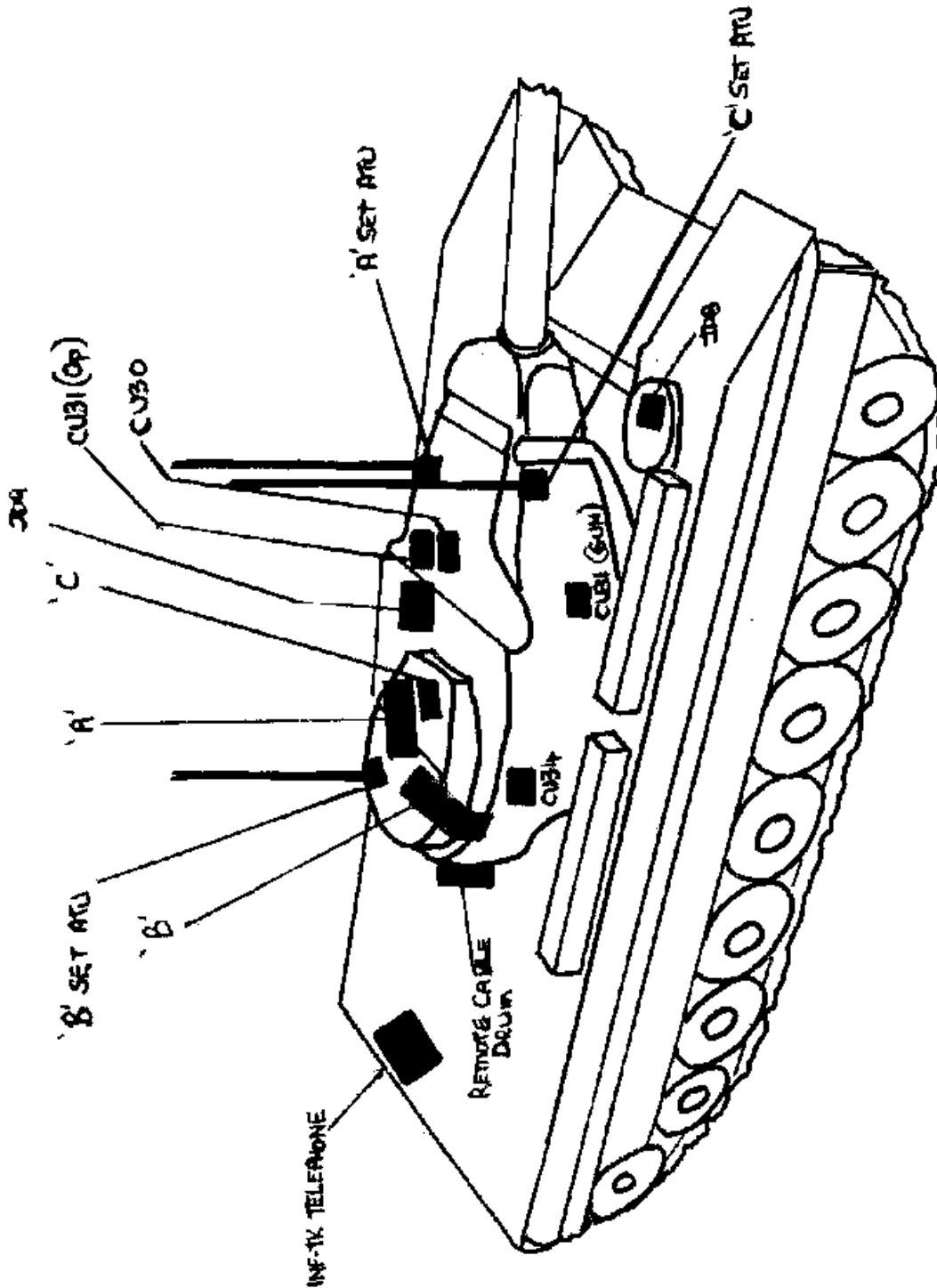

Figure 39

RESTRICTED

2 - 71. do not the



RESTRICTED

3 - 27

- f. Adjust the volume of the monitored sets in the right earphone (using the Monitor GAIN on the CU34) to a lower level than the selected set/IC.
- g. To transmit on one of the sets, select the required set on the microphone and press the press-to-talk switch.
- h. To use the "live microphone" on IC, select "I" and speak (without pressing the press-to-talk switch). For CRASH-IC, press the press-to-talk switch.
- i. If the monitored sets are drowning out the selected set, switch the headset monitor OFF temporarily.

Fire Alarm Circuit

83. The Fire Alarm Horn is wired into the A3 Harness via the junction box in the drivers compartment. This junction box is located between the JD8 and the Fire Alarm Horn on the left-hand wall of the compartment. Two wires from the horn circuit feed into the screened cable to the drivers JD8. This ensures that the driver will hear the fire alarm in the headphones should it be set off. Fuse "C", in the drivers switchboard, protects the fire alarm circuit.

Opening Up Drills

84. The Opening Up Drills on the A2/3 Control Harness are as follows:-

- a. Ensure that the sets have been tested and tuned.
- b. Ensure that the sets are re-connected to the JD9.
- c. Check the security and condition of all junction boxes, control units, leads and connectors.
- d. Check the operation and security of all switches and controls.
- e. Ensure that all crewmen's microphones have been previously tested.
- f. Connect the Commanders, Operators, Gunners and drivers microphones to the respective control units.
- g. Connect the Remote Handset to the remote cable.
- h. If a CU30 is fitted, ensure that the NOR/REB switch in the JD9 is at "REB".
- i. Ensure that the switches on the CU30 are at "NORM" and "AUTO".
- j. Ensure that the "A" set IC is switched to "ON".
- k. Connect the Tannoy to the Battery Balancer Box.

RESTRICTED

3 - 28/. Carry

RESTRICTED

3 - 28

1. Carry out the Tests.

Note:

The following Tests are for an A3 Control Harness. If using an A2 Control Harness, delete any tests involving the "B" set.

Tests

85. The Tests on the A2/3 Control Harness are as follows:-

Note:

No set will transmit during periods of radio or electronic silence.

	Test	Result	Fault	Action
a.	<u>POWER SUPPLY</u> (1) Switch on JD9	CU31 lamps light	No light on either CU31	a. Check dimmers b. Check bulbs - change c. Press call switch for 10 secs (either CU31) d. Report
b.	<u>OPERATORS CU31</u> (1) Connect Headset and operate call switch	Call signal heard	No call	a. Check JD9 fuse - change b. Report
			No buzz but JD9 relays operate	Report IC fault
	(2) Select IC press press-to-talk switch	Sidetone	No sidetone	Report
	(3) Select "A" set	Set noise heard	No set noise	a. Press call switch for 10 secs. b. Report
	(4) Vary gain	Noise varies	No change	Report
(5) Press press-to-talk switch and speak into microphone	Set sends and sidetone heard	No send or sidetone	Report	

RESTRICTED

3 - 29/. Repeat

RESTRICTED

3 - 29

	Test	Result	Fault	Action
	(6) Repeat tests with "B" & "C" sets selected in turn. As for b. (3)	As for b. (3)	As for b. (3)	As for b. (3)
c.	<u>GUNNERS CU31</u>			
	(1) Connect Headset and operate call switch	Call signal heard	No call	a. Check JD9 fuse - change b. Report
			No buzz but JD9 relays operate	Report IC fault
	(2) Select IC press press-to-talk switch	Sidetone	No sidetone	Report
	(3) Select "A" set	Set noise heard	No set noise	a. Press call switch for 10 secs b. Report
	(4) Vary gain	Noise varies	No change	Report
	(5) Press press-to-talk switch and speak into microphone	Set sends and sidetone heard	No send or sidetone	Report
	(6) Repeat tests with "B" & "C" sets selected in turn, as for c. (3)	As for c. (3)	As for c. (3)	As for c. (3)
d.	<u>CU34 AND NO. 5 MICROPHONE</u>			
	(1) Switch monitor ON/OFF (on handset) to OFF. Switch all monitor switches on CU34 to OFF. Select "A", "B" & "C" sets in turn	Set noise heard in both ear-phones	No noise in one or both ear-phones	a. Change ear-phones b. Change microphone c. Report

RESTRICTED

3 - 30/. Press

RESTRICTED

3 - 30

Test	Result	Fault	Action
(2) Press press-to-talk switch and speak, select "A", "B" and "C" in turn	Sidetone heard and set selected goes to send	No sidetone on set selected. Does not go to send	a. Change microphone b. Report
(3) "A", "B" or "C" selected. Switch monitor ON/OFF to ON (On h'set).	Left earphone goes dead. Set noise continues in right earphone	Result is vice versa	a. Check headset is not on back to front b. Report
(4) Vary left hand gain on CU34	Gain in right earphone varies	No variation	Report
(5) Select IC. Switch monitor switches on CU34 to ON then OFF for "A", "B" and "C" in turn.	Set noise in left earphone as each monitor switch is switched on	No set noise	a. Change microphone b. Report
(6) With monitor "C" left on vary right hand gain control	Set noise varies	No variation	Report
(7) Switch monitor ON/OFF (On h'set) to OFF with IC selected, speak into microphone (without pressing Press-to-talk)	Sidetone heard	No sidetone	a. Change microphone b. Report
(8) Leave IC selected press press-to-talk switch	IC heard by all crew members irrespective of sets selected on CU31s	No IC	a. Change microphone b. Report
(9) Press press-to-talk switch and speak into microphone, vary gain	Sidetone volume varies	No sidetone or variation	Report
(10) Operate call buzzer on the operators CU31	Call heard in commanders earphones	No call	Report

RESTRICTED

3 - 31/. Ensure

RESTRICTED

3 - 31

	Test	Result	Fault	Action
e.	<u>CU30 FOR AUTOMATIC REBROADCAST</u>			
	(1) Ensure all sets at noise off. Listen on operators h'set. Switch left-hand switch on CU30 to AB. Right-hand switch to AUTO  Switch OP CU31 to B. Turn up A set squelch and reduce	Noise heard and "E" set sends when squelch turned up.	No noise or send	Report
			B set continues to send when squelch turned down	a. Change B set freq to at least 8mhz from A set freq but not in a multiple of six  b. Report
	(2) Switch the operators CU31 to "A". Turn up the "B" set squelch and then reduce.	Noise heard and the "A" set sends when squelch is turned up	No noise or send	Report
			"A" set continues to send when the squelch is turned down	Report
	(3) Right hand switch on CU30 to "Break-in" press press-to-talk switch	Both sets send	No send	Report
	(4) Repeat paras e. (1), (2) & (3) AC and BC as necessary	As for e.(1), (2) & (3)	As for e.(1), (2) & (3)	As for e.(1), (2) & (3)

Note: Ensure switches are at "Norm" and "Auto" when finished.

RESTRICTED

3 - 32/. Left-hand

RESTRICTED

3 - 32

	Test	Result	Fault	Action
f.	<u>CU30 USED FOR MANUAL REBROADCAST</u>			
	(1) Left-hand switch on CU30 to AB. Right-hand switch to - C - A C - B B - A	A set sends	No send	Report
	(2) Right-hand switch to - A - C B - C A - B	B set sends	No send	Report
	(3) REPEAT TESTS FOR BC AND AC ENSURE CU30 IS RETURNED TO		AS NECESSARY NORM AND AUTO	
g.	<u>REMOTE HANDSET</u>			
	(1) Switch remote ON/OFF on JD9 to ON, Op CU31 to A.  A set to noise on	Noise heard in headset	No noise	a. Change h'set b. Check cable and drum
			No noise but set goes to send	a. Change h'set b. Check cable and drum for short c. Report
	(2) Press press-to-talk switch & speak into microphone	Set sends sidetone heard	No send or sidetone	a. Change h'set b. Report
(3) Operate call button	Call signal heard	No call	a. Change h'set b. Report	
	(4) Op CU31 to IC Press h'set press-to-talk switch and speak into microphone	Speech heard in Op h'set	No speech	Report
h.	<u>INF/TK TELEPHONE</u>			
(1) Check operation of cable drum and return spring. Operate call switch	Call signal heard	No call	Report	

RESTRICTED

3 - 33/. Press

RESTRICTED

3 - 33

	Test	Result	Fault	Action
	(2) Press press-to-talk switch and speak into microphone	Sidetone heard	No sidetone	Report
i.	<u>TANNOY</u> (1) Connect Tannoy to BB Ex. Switch A set off. Switch JD9 off. Press press-to-talk switch and speak into microphone (BB - BATTERY BALANCER)	IC heard in Drivers h'set	No IC heard	a. Change tannoy b. Report
j.	<u>AUDIO EXTENSION LEADS - APPROX 9m (30 Ft)</u> (1) Connect 6 and 12 pin extension leads to appropriate headsets and control units. Select "A" set. Press the press-to-talk switch	Sets send Sidetone heard	No send or sidetone	Report

Note: Remove and stow any equipment that will not be used during the days operation.

Closing Down Drills

86. The Closing Down Drill on the A3 Control Harness is as follows:-

- a. Ensure that all radio sets are OFF.
- b. Switch the Power ON/OFF switch on the JD9 to OFF.
- c. Remove and stow all audio equipment (if closing down for a long period).
- d. Check the security and cleanliness of leads, junction boxes, control units and components.
- e. Report/replace any defective equipment.
- f. Switch off the vehicle master switch.

RESTRICTED

CHAPTER 4 - AN/VIC 1 (V) CONTROL HARNESSGeneral

87. The AN/VIC 1 (V) Control Harness is designed to be used in vehicles that do not have an intercommunication system incorporated in one of the radio sets. It enables the crew to communicate with each other within the vehicle and control up to three radio sets.

Configurations

88. The AN/VIC 1 (V) Control Harness is used in the majority of RAAC Armoured Fighting Vehicles. The number of Control Units used in the harness will depend on the types and role of the vehicle that it is used in. The number and type of radio set controlled by the harness will also depend on the role of the vehicle. The types of radios that can be used in the harness are:-

- a. AN/VRC 53 (receiver-transmitter).
- b. AN/VRC 64 (receiver-transmitter).
- c. AN/VRC 46 (receiver-transmitter).
- d. AN/VRC 49 (two receiver-transmitters).
- e. R-442/VRC (receiver) (US only).

Components

89. The components that make up the AN/VIC 1 (V) Control Harness are as follows:-

- a. Amplifier Audio Frequency AM-1780/VRC.
- b. Control Intercommunication Set C-2298/VRC.
- c. Electrical Power Cable Assembly CX-4720/VRC.
- d. Special Purpose Cable Assembly CX-4723/VRC.
- e. Headset-Microphone H-161/GR or H-161A/U.
- f. The following equipment can be used with the harness:-
  - (1) Controls Intercommunication Set C-2296/VRC.
  - (2) Control Intercommunication Set C-2297/VRC.
  - (3) Control Radio Set C-2299/VRC.
  - (4) Handset H-207/VRC.



Power Supply

90. Power required is 24 volts d.c. (direct current). This voltage can be provided by the radio set or direct from the vehicle generating system or radio batteries. The harness uses between 1 and 1.5 amperes.

Component Construction

91. All junction and control units are of cast aluminum construction, although the sizes and shapes vary according to the function of the unit. Each unit is hermetically sealed to render it moisture and dust proof. Mounting points are located on the rear of each unit (rubber bushes are fitted between the mounting points and the vehicle body to act as shock absorbers). A raised flange on the front of all units, provides protection for the switches and controls. Screw-on dust covers are provided to protect the connections when not in use, and all sockets are marked with designators for easy identification. The name and registered number is located on an inscription plate on the front or side of the unit.

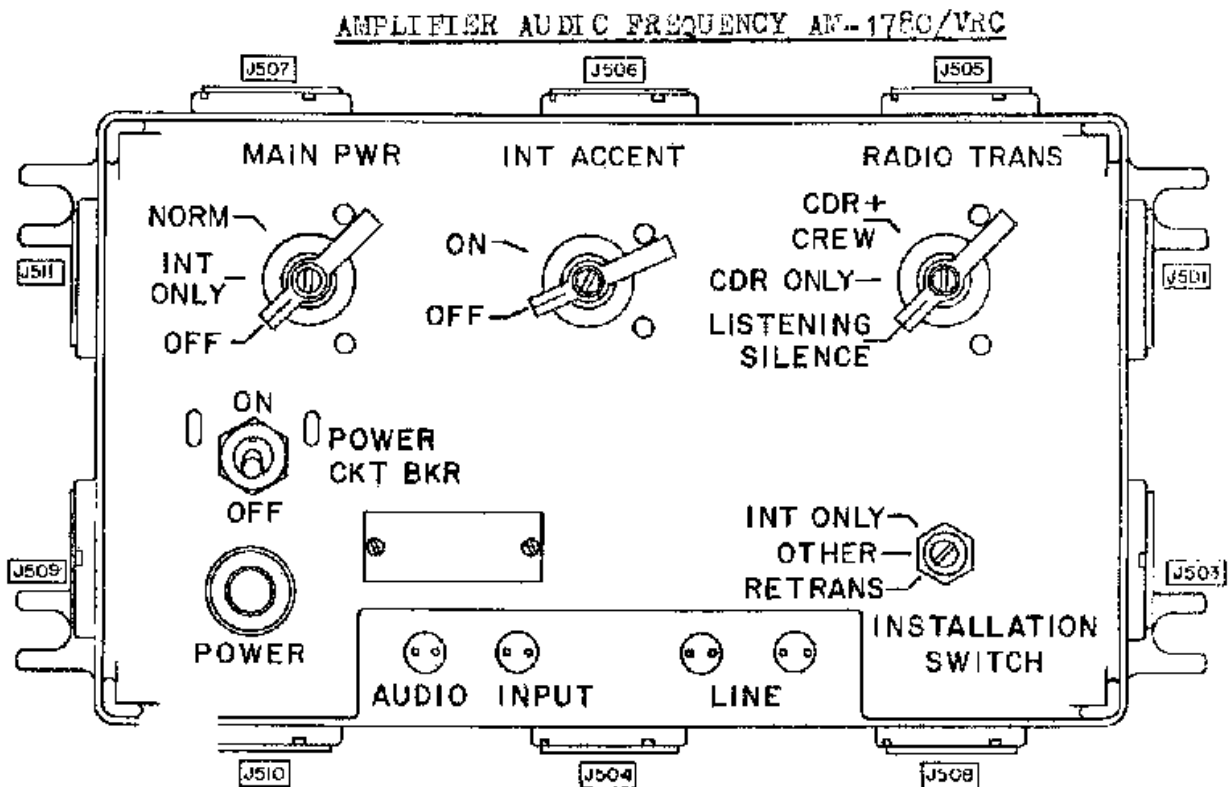

Figure 40

Amplifier Audio Frequency AM-1780/VRC (See figure 40)

92. This unit is the focal point of the AN/VIC 1 (V) harness, and amplifies the intercommunication and receiver outputs of the individual control units. All operating controls are external and it is fitted with four mounting points.

4 - 3/. The connections

AM-1780/VRC Connectors

93. The connectors on the AM-1780/VRC are as follows:-
- a. J507. 18 pins. Connects the gunners C-2298 via a CX-4723/VRC cable.
  - b. J506. 18 pins. Connects the operators C-2298 via a CX-4723/VRC cable.
  - c. J505. 18 pins. Connects the drivers C-2297 via a CX-4723/VRC cable.
  - d. J501. 18 pins. Connects the "A" set mounting tray via a CX-4723/VRC cable.
  - e. J503. 18 pins. Connects the "C" set mounting tray via a CX-4723/VRC cable.
  - f. J508. 4 pins. Used to power the harness for inter-communication purposes when no radio sets are fitted. Power is fed straight from the vehicle generating system or batteries via a CX-4720/VRC cable.
  - g. J504. 18 pins. Used to connect the commanders C-2298 via a CX-4723/VRC cable.
  - h. J510. 9 pins. Used to connect the "B" set mounting tray via a CX-7616/V cable for receiving only (R-442).
  - i. J509. 18 pins. Used to connect a C-2299 for automatic rebroadcast via a CX-4723/U. The J509 connects to the J702 socket on the C-2299/VRC, and controls the "C" set.
  - j. J511. 18 pins. Used to connect a C-2299 for automatic rebroadcast via a CX-4723/U. The J511 connects to the J701 socket on the C-2299/VRC, and controls the "A" set.

Note

- a. The J505 socket can be used to connect the drivers C-2297/VRC instead of a C-2298/VRC.
- b. The control units that connect to the J507, J506 and J505 sockets can be inter-changed on these sockets without effecting the units.
- c. The commanders control unit MUST be connected to the J504 to get the COMD ONLY facility.

AM-1780/VRC Controls and Switches

94. The controls and switches on the face of the AM-1780 are as follows:-

- a. Main Power Switch. A three position switch that controls the radio set system power. The three switch

RESTRICTED

4 - 4

positions are as follows:-

- (1) OFF. Turns system power off.
  - (2) INT ONLY. (Internal Only). Turns on the system power for intercommunications when the INSTALLATION switch is at INT ONLY. Only used when radios are not fitted.
  - (3) NORM. (Normal). Turns on system power for radio and intercommunications.
- b. Internal Accent Switch. Adjusts relative loudness of intercommunication and radio signals. The two switch positions are as follows:-
- (1) OFF. Radio and intercommunications signals have same volume.
  - (2) ON. Intercommunications signals are louder than radio signals.
- c. Radio Transmission Switch. Determines which units can control the receiver-transmitters. The three switch positions are as follows:-
- (1) CDR + CREW. Commander and crew boxes can control receiver-transmitters.
  - (2) CDR ONLY. Commander only can transmit and receive. Rest of crew can receive only.
  - (3) LISTENING SILENCE. Commander and crew cannot transmit. All can receive.
- d. Installation Switch. Selects the mode of operation. The three switch positions are as follows:-
- (1) INT ONLY. Used in conjunction with the INT ONLY position on the Main Power Switch. Used when no radios are fitted and the harness is powered via the J508 socket from the vehicle generating system or batteries.
  - (2) OTHER. Normal operation of the harness.
  - (3) RETRANS. Switched to this position when a C2299 is fitted to the harness. Enables either rebroadcast or normal operation.

Note:

The installation switch is adjusted with a screwdriver, and is not to be adjusted by other than qualified personnel.

4 - 5/. Two push-in

RESTRICTED

RESTRICTED

4 - 5

- e. Line Terminals. Two push-in plastic line terminals are provided for the connection of a field telephone. The field telephone is connected to the intercommunication circuit. The IC circuit can also be interconnected between two vehicles by joining the line terminals on each AM-1780 by wire.
- f. Audio Input Terminals. Two push-in plastic audio input terminals are provided for the connection of an Anti-aircraft Artillery Intelligence Service Receiver (AAAISR).
- g. Power Indicator Lamp. When illuminated, it indicates that power is connected and the POWER ONT PWR switch is on (this lamp is fitted with a rotary dimmer shield and is for blackout purposes). The bulb used is a 28 volt, 0.04 ampere Pee Bulb.
- h. Power Circuit Breaker Switch. Controls the power to the harness and provides an overload circuit breaker to protect the harness. The switch will automatically switch off if there is an overload in the harness. This circuit breaker operates at approximately 1.5 amperes.

Note:

The Power Circuit Breaker switch is a very delicate toggle switch that could be damaged if care is not taken when using it.

CONTROL INTERCOMMUNICATION SET

C-2298/VRC

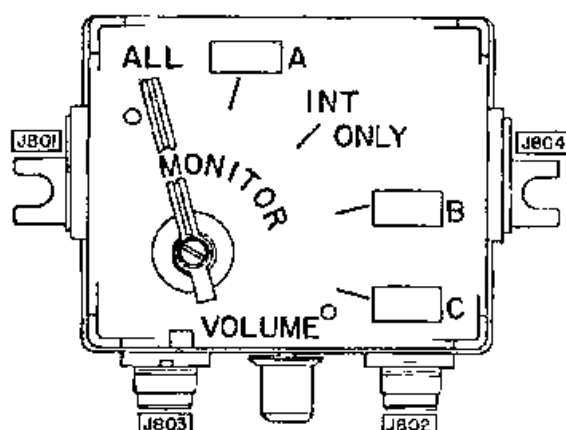

Figure 41

Control Intercommunication Set C-2298/VRC

95. This unit provides connections between the AM1780/VRC and the audio accessories used by the gunner, operator and commander. It enables these crewmen to monitor and select the facility required. In the RAAC, the driver also uses a C-2298.

4 - 6. The connectors

RESTRICTED

4 - 6

C-2298/VRC Connectors

96. The connectors on the C-2298/VRC are as follows:-
- a. J804. 18 pins. Can be used to connect the unit to the AM-1780/VRC or to a further control unit. The cable used is a CX-4723/VRC.
  - b. J801. Same as for para a. above.
  - c. J802. 5 pins. Permits connection for the audio equipment for control of the radio facilities.
  - d. J803. 5 pins. Permits connection for the audio equipment for control of the intercommunication facilities. When connecting a H-161/GR, the lead with the yellow band must be connected to this socket otherwise the breastplate switch operation will be reversed.

C-2298/VRC Switch and Control

97. The C-2298/VRC has one switch and one control, and these are:-
- a. Monitor Switch. This switch enables the user to select the required operating position. The five positions are:-
    - (1) ALL. Can monitor all receivers (A, B and C sets), and can transmit on the "A" set. If using a H-161/GR, the IC facility can be used.
    - (2) "A". Can receive and transmit on the "A" set and use the IC (with H-161/GR).
    - (3) INT ONLY. Can transmit and receive on the intercommunication system only.
    - (4) "B". Can receive on the "B" set and transmit on the "A" set. IC can be used with a H-161/GR.
    - (5) "C". Can receive and transmit on the "C" set. If the C-2298/VRC is connected to the J504 socket on the AM-1780/VRC, can use the IC for transmit and receive.

If the C-2298/VRC is connected to the J507, J506 or J505 sockets on the AM-1780/VRC, the user can only receive on the IC.
  - b. Volume Control. Located between the J802 and J803 sockets, and controls the audio output at both of those sockets. It is rotated clockwise to increase the volume.

Note:

White rectangular tabs are located at the "A", "B" and "C" set switch positions to enable the user to inscribe the frequency, call-sign or net call-sign etc., of the particular radio net that the individual set is on.

RESTRICTED

4 - 7/. This unit

RESTRICTED

4 - 7

CONTROLS, INTERCOMMUNICATION SET C-2296/VRC

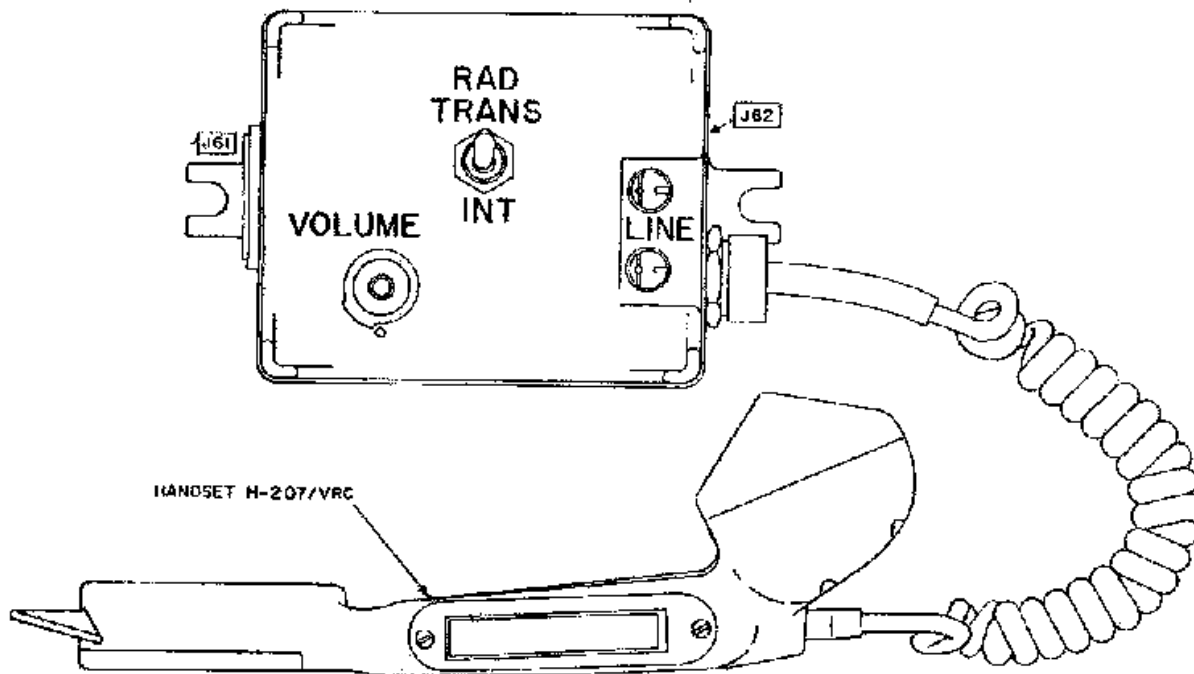

Figure 42

Controls, Intercommunication Set C-2296/VRC

98. This unit is fitted to the outside of a vehicle, and enables the user to use the transmit-receive facilities of the sets and IC. It also enables a field telephone to be connected to the harness. This unit is controlled by the drivers C-2297/VRC.

C-2296/VRC Connectors

99. The connectors on the C-2296/VRC are as follows:-
- a. J62. To connect an indicator lamp. When this lamp is illuminated, it indicates that the user at the C-2296 is being called. Also, this lamp will illuminate when the user presses his press-to-talk switch, and it will remain on until he is answered. The J62 has 4 pins.
  - b. J61. To connect to the J901 socket on the C-2297/VRC via a cable CX-7057/V. This cable connects the C-2296 to a junction box fitted to the vehicle. A cable, CX-7056/V, connects the junction box to the C-2297/VRC. The J61 socket has 9 pins. (The junction box has 14).

RESTRICTED

4 -8/. Two plastic

RESTRICTED

4 - 8

- c. Line Terminals. Two plastic, push-in line terminals are provided to connect a field telephone. The telephone works into the IC circuit.
- d. Handset H-207/VRC Connector. The flexible handset cord is wired into the C-2296, and cannot be removed. The handset has a receiver and microphone element, and a press-to-talk bar.

C-2296/VRC Switch and Control

100. The C-2296/VRC has one switch and one control. These are:-

- a. RADIO TRANSMISSION-INT Switch. This switch has two positions, and these are:-
  - (1) INT. Selects intercommunication operation.
  - (2) RAD TRANS. A spring-loaded position. This has to be used in conjunction with the press-to-talk bar on the H-207/VRC to transmit over a radio set. The radio set controlled by the C-2296/VRC will be determined by the position of the Monitor switch on the C-2297/VRC.
- b. Volume Control. Adjusts the volume in the H-207/VRC receiver.

CONTROL, INTERCOMMUNICATION SET C-2297/VRC

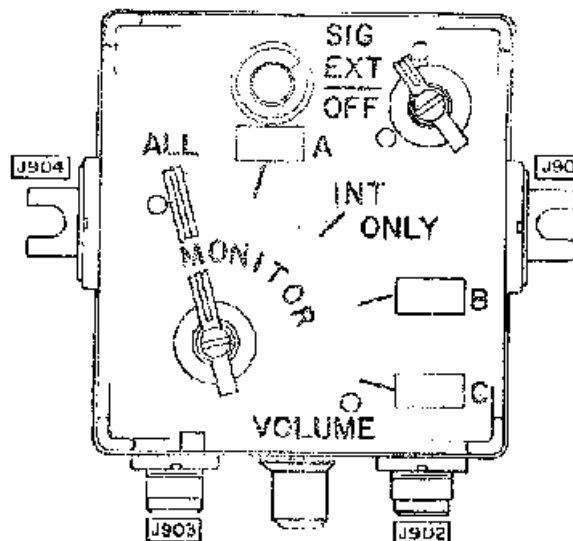

Figure 43

RESTRICTED

4 - 9/. This unit

RESTRICTED

4 - 9

Control, Intercommunication Set C-2297/VRC

101. This unit is the drivers control unit, and provides him with set and IC selection, and control over the C-2296/VRC external unit.

C-2297/VRC Connectors

102. The connectors on the C-2297/VRC are as follows:-
- a. J901. 9 pins. To connect the C-2296/VRC via a cable, CX-7057/V or CX-7055/V.
  - b. J904. 18 pins. To connect the C-2297/VRC to the AM-1780/VRC via a cable, CX-7060/V.
  - c. J902. 5 pins. Connection for audio equipment for control of radio facilities.
  - d. J903. 5 pins. Connection for audio equipment for control of intercommunication facilities.

Note:

- e. A microphone, M-80/GR can be connected to the J903 socket.
- b. A headset, H-140/GR can be connected to the J902 socket.
- c. A microphone-headset H-161/GR can be used instead of the M-80 and H-140.

C-2297/VRC Switches and Controls

103. The switches and controls on the C-2297/VRC are as follows:-
- a. Volume Control. Controls the volume in the earphones of the audio equipment connected to the J902 and J903 sockets.
  - b. Monitor Switch. Same as for the Monitor switch on the C-2298/VRC. Refer to para 97 for a detailed description. Also, this switch controls the set/IC selection for the C-2296/VRC.
  - c. SIGNAL Switch. This switch controls the connection/disconnection of the C-2296/VRC. The three switch positions are as follows:-
    - (1) OFF. Switches the C-2296/VRC OFF.
    - (2) EXT. (Extension). Connects control workings to the C-2296/VRC. (The C-2297/VRC extension lamp lights).
    - (3) SIG. (Signal). This is a spring-loaded position, and it signals the operator at the C-2296/VRC by illuminating the extension lamp on the C-2296/VRC.

RESTRICTED

4 - 10/. Indicates



RESTRICTED

4 - 10

- d. Extension Indicator Lamp. Indicates that the C-2296/VRC is ~~in use or~~ that the operator at the C-2296/VRC wishes to communicate with the crew inside the vehicle.

Control, Radio Set C-2299/VRC

104. This unit enables Automatic Retransmission ( Rebroadcast ) to be used, and enables two radio sets to be controlled remotely. When the C-2299/VRC is connected to the harness, it can only be used for automatic retransmission, as no audio signals can be heard through the audio equipment connected to the J703 or J704 sockets.

CONTROL, RADIO SET C-2299/VRC

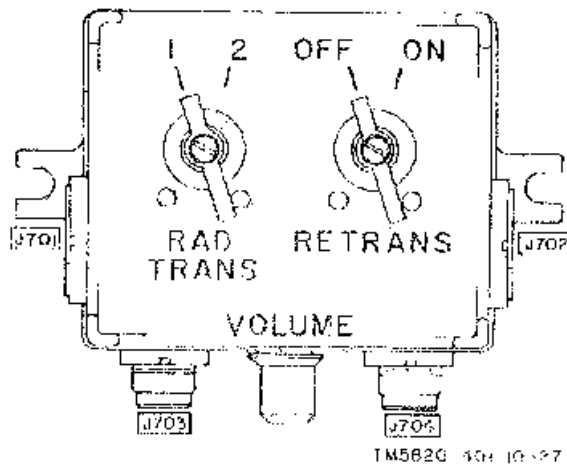

Figure 44

Control, Radio Set C-2299/VRC Connectors

105. The connectors on the C-2299/VRC are as follows:-
- a. J702. For connection to the J509 socket on the AM-1780/VRC via a cable CX-4723/U. The socket has 18 pins, and connects the "C" set circuit to the C-2299/VRC. If no harness is being used, the cable from the J702 socket would connect straight to the J22 socket on the "C" set Mounting Tray.
  - b. J701. For connection to the J511 socket on the AM-1780/VRC via a cable, CX-4723/U. The socket has 18 pins, and connects the "A" set circuit to the C-2299/VRC. If no harness is being used, the cable from the J701 socket would connect straight to the J22 socket on the "A" set Mounting Tray.

4 - 11/. Audio

RESTRICTED

RESTRICTED

4 - 11

- c. J703 - J704. Audio connectors for a headset-microphone assembly.

C-2299/VRC Switches and Control

106. The switches and control on the C-2299/VRC are as follows:-
- a. Volume Control. Adjust the volume in the earphones of the audio equipment connected to the J703 and J704 sockets.
- b. Radio Transmission Switch. This switch selects the radio set to be controlled when the C-2299/VRC is connected directly to the radio set Mounting Tray. The two switch positions are as follows:-
- (1) 1. Selects the "A" set for receive and transmit control at the C-2299/VRC.
- (2) 2. Selects the "C" set for receive and transmit control at the C-2299/VRC.
- c. Retransmission Switch. This switch selects remote control or retransmission. The two switch positions are as follows:-
- (1) OFF. Retransmission switched OFF, and Remote control selected. The remote control facility cannot be used when the C-2299/VRC is connected to the AM-1780/VRC.
- (2) ON. Retransmission is switched ON, and rebroadcast can take place.

Note:

When using the C-2299/VRC as part of the harness, the unit cannot monitor the rebroadcast circuit.

Headset-Microphone H-161A/U or E-161/CR

107. The Headset-Microphone H-161A/U provides facilities for radio and intercommunication reception and transmission. It can be used with vehicular or portable radio sets. This unit consists of two earphone cup assemblies, a headband assembly, microphone and boom assembly, neck strap-suspended chest set assembly (switch), retractile cable assembly, and a headset card assembly. These assemblies are as follows:-

- a. Earcup Assembly. The earcup assembly consists of an earphone, earphone retainer, transformer, earcup plate, and earcup cushion. The earcup and earcup plate are made of lightweight high impact plastic.

RESTRICTED

4 - 12/. (illus)

RESTRICTED

4 - 12

HEADSET - MICROPHONE II - 161A/U

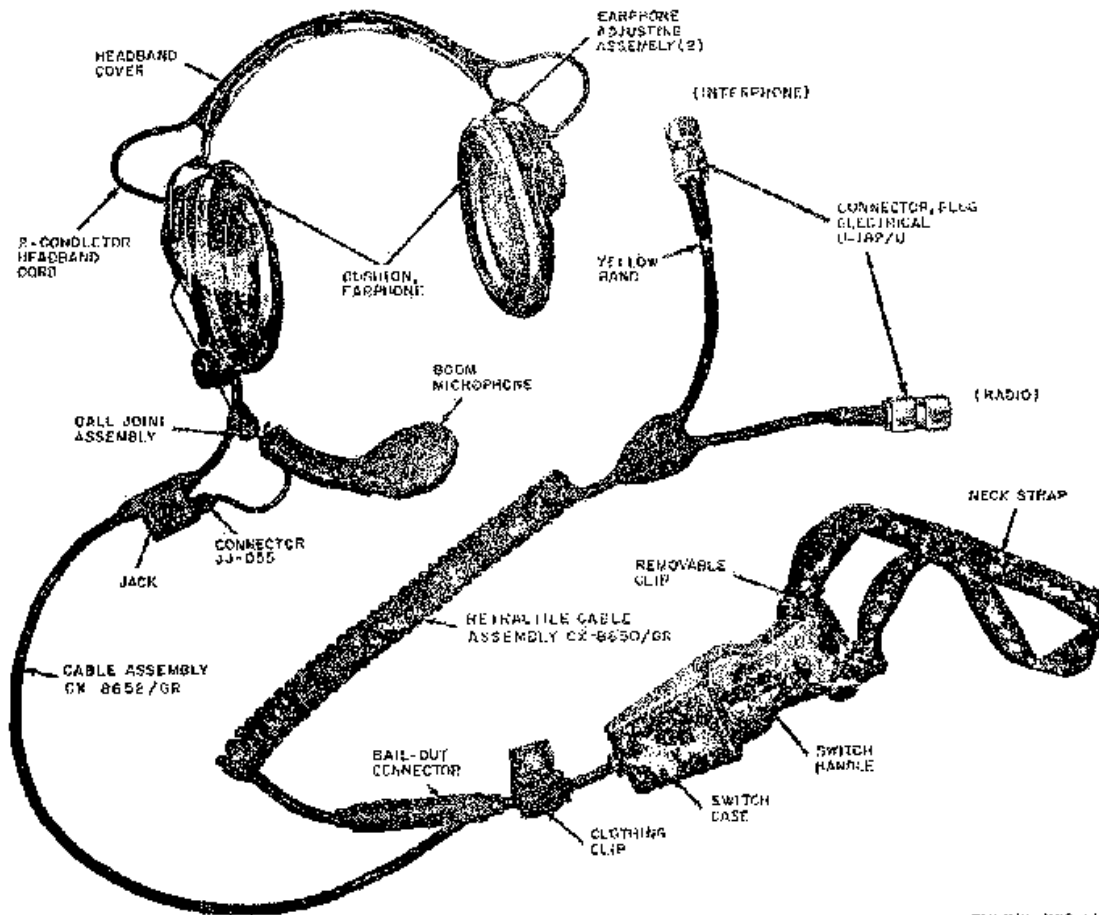

TM9265-262-15-1

Figure 45

FORGIVEN STATE

4 - 13/. The microphone

RESTRICTED

4 - 13

- b. Microphone and Boom Assembly. The microphone and boom assembly holds the microphone close to the operators lips, and helps eliminate background noise. The boom microphone case is made of lightweight high impact plastic.
- c. Chest Switch Assembly. The chest switch assembly employs a three-way selector switch to select the circuit over which the user wishes to talk and listen.
- d. Sliding Headband. The plastic covered metal headband can be adjusted by placing the earphones on, holding one earphone, and pushing up or down on the other earphone until the earphone is in position. Reverse the action for the opposite earphone.
- e. Retractable Cable. This is an extendable coil cable used to connect the headset-microphone assembly to a receiver-transmitter or a control unit (i.e., a C2298/VRC). One end of the cable terminates in a two pin bail-out connector, which is designed to separate (i.e., if the user is thrown out of a vehicle). The opposite end divides into two separate leads, with each lead terminating in a five pin connector. These connectors connect to the radio or control unit. One lead is fitted with a yellow coloured band (the longer one), and this connects to the IC socket on a control unit. The other connects to the radio socket.
- f. Switch and Switch Case. The plastic switch case is fitted with removable and adjustable neck and chest straps. On top of the casing is a three position switch. These are
  - (1) ICS (Intercommunication System). Used to transmit on the IC. If fitted directly to a radio set, the radio will transmit, and continue to do so until the switch is moved.
  - (2) OFF. This is the central position. In this position, the user can receive only.
  - (3) RAL (Radio). This is a spring-loaded position, and when released, will return to OFF. This position is used to transmit over the radio set selected on the control unit (or the radio set, if connected directly to it).
- g. Boom Microphone Adjustment. The boom can be adjusted in two ways. These are:-
  - (1) Ball Joint. A balljoint is located at the inner end of the plastic boom casing to enable the user to make adjustment inwards and away from the face, and to a limited extent, up and down.

4 - 14/. A tension

RESTRICTED

RESTRICTED

4 - 14

- (2) Tension Nut. A tension nut clamps the boom slide to one earphone. This nut can be loosened to enable the user to make large adjustments to the position of the microphone. The boom slide can be moved in and out, up and down when the tension nut is loose.

Note:

If the two, five pin connectors on the H-161A/U are not connected to the correct sockets on the control units, the breast-plate selector switch operation will be reversed.

CVC (Combat Vehicle Crewman) Helmet 256-G

108. The CVC Helmet is fitted with either the Headset-Microphone Kits MK-525/G or MK-526/G. The MK-525/G is fitted to the LARGE size helmets, and the other to the MEDIUM size helmets. A further headset-microphone kit, the MK-1039/G is similar to the other two, and can be fitted to both the LARGE and MEDIUM size helmets. Each kit is used for listening and speaking on the radio and intercommunication systems. Each kit has a pair of cushioned earphones, a microphone boom assembly (refer to para 107 for a description of the boom assembly), a switch assembly and a retractile cord with two five pin connectors (to connect the helmet to a control unit).

CVC Helmet Switch Assembly

109. The switch assembly has a three position switch and it is located on the left-hand side of the helmet. The three switch positions are identical to the H-161A/U (refer to para 107 for a description).

Operation of the Harness for IC ONLY

110. To use the AN/VIC-1 (V) Control Harness for IC purposes, when no radios or mounting trays are fitted, carry out the following:-
- a. Connect the 4 pin, CX-4720/VRC power lead from the vehicle generating system, to the J508 socket on the AM-1780/VRC.
  - b. Switch the MAIN POWER switch to INT ONLY.
  - c. Switch the INSTALLATION switch to INT ONLY. (authorised persons only).
  - d. Switch the POWER CIRCUIT BREAKER switch to ON.
  - e. Switch the MONITOR switch on all control units to INT ONLY.
  - f. The harness can now be used for intercommunication purposes.

4 - 15/. If mounting

RESTRICTED

RESTRICTED

4 - 15

CVC HELMET T56-6 ASSEMBLY

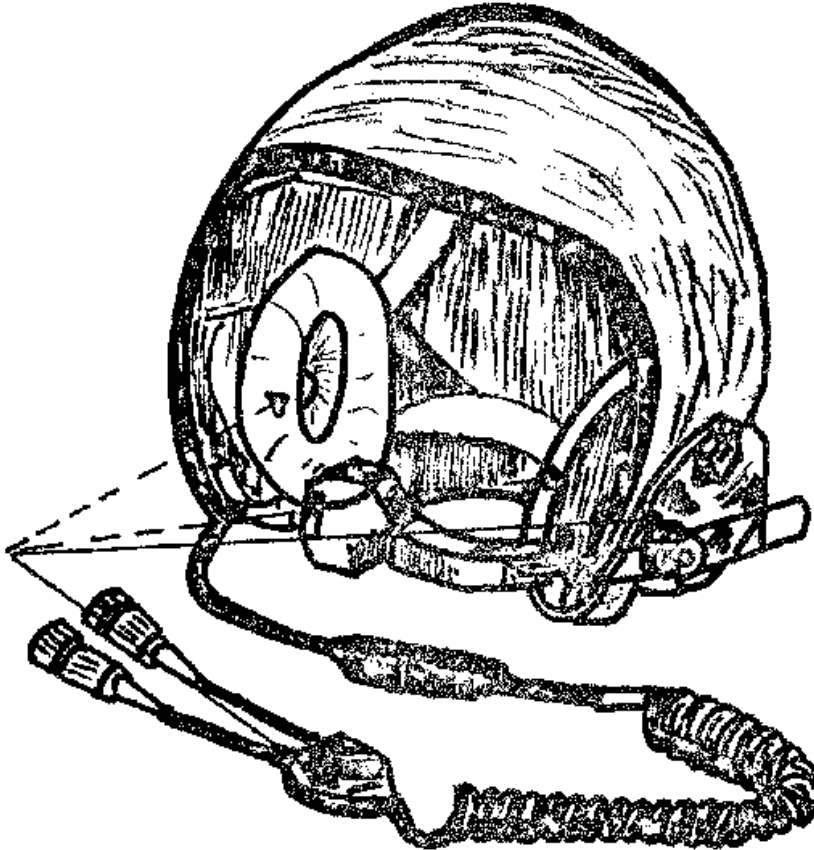

Figure 46

- a. If mounting trays are fitted to the vehicle, and the trays are connected to the harness, but no radios are fitted, carry out paras b. to e. for the same result. (page 4 - 14).

Operation of the AM-1780/VRC, with Radios Fitted

- 11 f The operating procedure for the AM-1780/VRC is as
- a. Ensure that the radio/radios have been tuned to the required frequencies.
  - b. Check the security of the CX-4723/VRC cables from the J22 sockets on the mounting trays to the "A", "B" and "C" set sockets on the AM-1780/VRC.
  - c. Switch the MAIN POWER switch to NORM.

4 - 16/. If the

RESTRICTED

RESTRICTED

4 - 16

- d. If the IC is required to be louder than the radio signals, switch the INT ACCENT switch to ON.
- e. Switch the RADIO TRANS switch to the required position, either CDR + CREW, CDR ONLY or LISTENING SILENCE.
- f. Ensure that the INSTALLATION switch is at OTHER (or RETRANS of a C-2299/VRC is fitted to the harness).
- g. Switch the POWER CKT BKR switch to ON (ensure that the power indicator lamp illuminates).

Note:

If the POWER CKT BKR switch moves to the OFF position, the circuit breaker has been activated and the harness will be switched off. Switch the POWER CKT BKR switch ON again. If it switches itself off again, report the fault to the Tel's mechanic.

Operation of the C-2296/VRC

112. To use the C-2296/VRC, carry out the following:-
- a. Switch the SIG-EXT switch on the C-2297/VRC to EXT.
  - b. To speak to crew members inside the vehicle, carry out the following:-
    - (1) Remove the H207/VRC from its stored position.
    - (2) Press the H-207 push-to-talk switch (as soon as the switch has been pressed, the extension lamp connected to the J62 socket will light. It will remain on until a crew member inside the vehicle answers).
    - (3) As soon as a crewman answers, press the push-to-talk switch and speak into the microphone.
    - (4) While listening, adjust the volume for a satisfactory level of listening.
  - c. To transmit over the radio set, carry out the following:-
    - (1) Press the H-207/VRC push-to-talk switch.
    - (2) Hold the RAD TRANS-INT switch in the RAD TRANS position.
    - (3) Speak into the microphone.
    - (4) At the completion of the transmission, release the H-207 push-to-talk switch and the RAD TRANS-INT switch.

RESTRICTED

4 - 17/. To communicate

RESTRICTED

4 - 17

- d. To communicate from a field telephone (K phone) carry out the following:-
  - (1) Connect field wire between the field phone and the terminals on the G-2296/VRC.
  - (2) Speak into the field telephone handset. (Voice will be heard at the G-2296/VRC on the IC).

Note:

When the extension lamp connected to the J62 lights, crew members inside the vehicle are trying to communicate with crew member at the G-2296/VRC. The lamp will extinguish when the G-2296/VRC operator answers.

Operation of the G-2297/VRC

113. To use the G-2297/VRC, carry out the following:-
  - a. Adjust the volume control for a satisfactory level of listening.
  - b. To transmit on the "A" set, carry out the following:-
    - (1) Turn the MONITOR switch to ALL, A or B.
    - (2) Press the selector switch on the H-161 to RAD and speak into the boom microphone.
  - c. To transmit on the "C" set, carry out the following:-
    - (1) Turn the MONITOR switch to C.
    - (2) Press the selector switch on the H-161 to RAD and speak into the boom microphone.
  - d. To communicate on the "C" set to internal crew members, carry out the following:-
    - (1) Turn the MONITOR switch to either ALL, A, INT ONLY or B.
    - (2) Press the selector switch on the H-161 to ICS and speak into the boom microphone.
  - e. To answer the operator at the G-2296/VRC, carry out the following:-
    - (1) After the EXT indicator lights, turn the SIG switch to EXT.
    - (2) Press the selector switch on the H-161 to ICS and speak into the microphone.

Note:

The EXT indicator lights as a reminder that the SIG switch is in the EXT position.

RESTRICTED

4 - 18/.To signal



RESTRICTED

4 - 18

- f. To signal the operator at the C-2296/VRC, carry out the following:-
  - (1) Hold the SIG switch in the SIG position.
  - (2) After the operator at the C-2296/VRC answers, release the SIG switch (it will return to the EXT position).
  - (3) Press the selector switch on the H-161 to ICS and speak into the microphone.

Operation of the C-2298/VRC

114. To use the C-2298/VRC, carry out the following:-
  - a. Adjust the volume control for a satisfactory level of listening.
  - b. To transmit over the "A" set, carry out the following:-
    - (1) Turn the MONITOR switch to either ALL, A or F.
    - (2) Press the selector switch on the H-161 to RAD and speak into the microphone.
  - c. To transmit over the "C" set, carry out the following:-
    - (1) Turn the MONITOR switch to C.
    - (2) Press the selector switch on the H-161 to RAD and speak into the microphone.
  - d. To communicate with other crew members, carry out the following:-
    - (1) Switch the MONITOR switch to either ALL, A, INT ONLY or B (if using the commanders C-2298/VRC, you can also switch to C).
    - (2) Press the selector switch on the H-161 to ICS and speak into the microphone.

Note:

The adjustment of the volume controls on the receiver-transmitters and receiver will effect the volume at the C-2298/VRC when the MONITOR switch is in any position except ALL. Adjust the receiver-transmitter and receiver, and the control unit volumes to an equal level when at ALL.

4 - 19/. To use

RESTRICTED

RESTRICTED

4 - 19

Operation of the C-2299/VRC

115. To use the C-2299/VRC when it is part of the AN/VIC 1 (V) harness, carry out the following:- (Refer to Chapter 6 - RAAC RADIO CONFIGURATIONS AND THEIR OPERATING PROCEDURES for detailed information on the use of a C-2299/VRC when it is connected directly to the radio set mounting trays).

- a. Notify the crew that retransmission is to be established.
- b. Tune the two sets to the required frequencies (frequencies must be at least 10 mhz apart and must be such that the transmitter of either receiver-transmitter will interfere with the receiver of the other. Use the RETRANSMISSION INTERFERENCE CHART as a guide).
- c. Ensure that both sets have their SQUELCH circuits ON.
- d. Ensure that the INSTALLATION switch on the AM-1780/VRC is at RETRANS.
- e. RAD TRANS switch can be left at either 1 or 2.
- f. Inform both "nets" that you are rebroadcasting their nets (select 1, then 2 in turn).
- g. Switch the RETRANSMISSION switch to ON (retransmission can now take place between the distant stations.)
- h. When retransmission is no longer required, ensure that the RETRANSMISSION switch is OFF.

Opening Up Drills

116. The Opening Up Drills on the AN/VIC 1 (V) harness is as follows:-

- a. Ensure that the Drills, Tests and Tuning has been carried out on all radio sets.
- b. Check the security and condition of all control cables.
- c. Check the security and condition of all control units and junction boxes.
- d. Check the security and operation of all switches and controls.
- e. Connect the audio equipment to the applicable control units.
- f. Switch the MAIN POWER switch to NORM.
- g. Ensure that the INSTALLATION switch is at RETRANS if a C-2299/VRC is fitted.
- h. Carry out the TESTS.

RESTRICTED

4 - 20/. The tests

RESTRICTED

4 - 20

Tests:

117. The Tests on the AM/VIC 1 (V) harness are as follows:-

Note:

No sets will transmit during periods of Radio or Electronic Silence.

Test	Result	Action
a. (1) <u>AM/1780 VRC</u> Turn main power switch to NORM. Turn power OKT BKR switch to ON.	POWER indicator lamp lights.	<u>If Lamp doesn't Light</u> (a) Check dimmer. (b) Check bulb. (c) Check CX-4723 from J501 to J22 on "A" set M-TRAY. (d) Report.
(2) Turn the RADIO-TRAN switch to CDR+CREW. Have another Radio set stand by to receive a signal on "A" set freq. Switch CDR C2298 to "A" and transmit.	OPERATOR at other set hears signal.	<u>If No Signal Heard</u> (a) Check H161 by substitution. (b) Check CX-4723 by substitution. (c) Check C2298 by substitution. (d) Report.
(3) Switch a crewmans C2298 to "A" and transmit.	OPERATOR at other set hears signal.	<u>If No Signal is Heard</u> As for para (2), (a), (b), (c), (d) above.
(4) Turn RADIO TRANS switch to CDR only and transmit from CDR's C2298.	OPERATOR at other set hears signal.	<u>If No Signal is Heard</u> (a) Check CX-4723 cable from C2298 is connected to J504 on AM1780. (b) Report.
(5) Transmit from a crewmans C2298.	No signal heard.	<u>If Signal Heard</u> a. Report.

4 - 21/. Turn

RESTRICTED

RESTRICTED

4 - 21

Test	Result	Action
(6) Turn RADIO TRANS switch to LISTENING SILENCE. Transmit from CIDR G2298.	No signal heard.	<u>If Signal Heard</u> (a) Report.
(7) Transmit from crewmans G2298.	No signal Heard.	<u>If Signal Heard</u> (a) Report.
(8) Whilst on LISTENING SILENCE get distant operator to transmit a test signal.	Signal heard.	<u>If no Signal Heard</u> (a) Report.
(9) Turn RADIO TRANS switch to CIDR+CREW. turn INT ACCENT switch to CN. Get distant operator to transmit test signal, at the same time have a crewman talk on IJ.	Both radio and IC signal heard with IC at a greater volume.	<u>If Radio &amp; IC at Same Level</u> (a) Report.
b. <u>G2298/VRC</u>		
(1) Turn "A" set squelch control to OFF. Select ALL, A in turn.	Rushing noise heard in the earphones in both positions.	<u>No Noise Heard</u> (a) Check H161, CX4723 and G2298 in turn by substitution. (b) Check CX4723 from J501 to J22. (c) Report.
(2) Select ALL, A, B in turn and transmit a test signal at each position.	Rushing noise cuts out "A" set goes to send.	<u>Noise Continues</u> (a) Check H161 by substitution. (b) Report.
(3) Switch "A" set squelch on and "B" set squelch off. Select ALL and "B" in turn.	Rushing noise heard in earphones in both positions.	<u>No Noise Heard</u> (a) Check CX-7058/V cable to J510 socket by substitution. (b) Report.

4 - 22/. Switch "B"

RESTRICTED

RESTRICTED

4 - 22

Test	Result	Action
(4) Switch "B" set squelch to ON and "C" set squelch to OFF. Select ALL and "C" in turn.	Rushing noise heard in ear-phones in both positions.	<u>No noise Heard</u> (a) Check CX4723 cable to J5C3 socket by substitution. (b) Report.
(5) Turn MONITOR switch to "C" and transmit a test signal.	Rushing noise cuts out and "C" set sends.	<u>Noise Continues</u> (a) Check H161 by substitution. (b) Report
(6) Turn "C" set squelch ON.		
(7) Switch to INT ONLY and transmit on the IC. Have second operator answer on IC.	Both operators receive signal on IC.	<u>If No Signal Heard</u> (a) Check H161, CX4723 C2298 in turn by substitution. (b) Report.
(8) Have second operator speak on IC. Rotate volume control.	Voice heard, volume varies.	<u>No Variation</u> (a) Check H161, C2298 by substitution. (b) Report.
(9) Select ALL, A,B,C in turn. Select ICS on H161 speak into microphone.	IC heard by all crew members. <u>Note</u> ; All crew members can hear IC with the monitor switch at IC. only the ODR can speak on IC. with monitor switch at "C".	<u>No IC Heard</u> (a) Check H161, C2298 by substitution. (b) Report.
c. <u>C2296/VRC</u> (1) Operate press-to-talk switch on H207.	Ext lamp lights.	<u>No Light</u> (a) Check bulb. (b) Check CX7056/V. by substitution. (c) Report.

RESTRICTED

4 - 23/. Hold press

RESTRICTED

4 - 23

Test	Result	Action
(2) Hold press-to-talk switch CLOSED.	Voice heard when operator at C2297 answers and ext lamp goes out.	<u>No Voice and Lamp Stay On</u> (a) Check H161 at C2297 by substitution. (b) Check C2297, C2296 in turn in substitution. (c) Report.
(3) Speak into H207 microphone.	Voice heard at C2297	<u>No Voice</u> Report.
(4) Have operator at C2297 speak into microphone. Rotate volume control.	Voice heard and volume varies.	<u>No Variation</u> (a) Check C2296 by substitution. (b) Report.
(5) Press the H207 press-to-talk switch and hold the RAD TRANS INT switch to RAD TRANS. Speak into microphone.	Operator at other set hears the signal.	<u>If No Signal Heard</u> (a) Check C2296 by substitution. (b) Report.
(6) Connect a field telephone to the remote terminals on C2296 and speak into telephone handset.	Operator at C2297 hears voice.	<u>No Voice Heard</u> (a) Check wire. (b) Check telephone. (c) Report.
a. <u>C2297/VRC</u> (1) As for tests on C2298 (See sub para b.) for C2297 monitor switch and volume control.	As for sub para b.	As for sub para b.
(2) Have operator at the C2296 press the press-to-talk switch on the H207.	Ext lamp lights on C2297.	<u>No Light</u> (a) Check bulb. (b) Check H207. (c) Check C2297. (d) Report.

RESTRICTED

4 - 24/.Momentarily

RESTRICTED

4 - 24

Test	Result	Action
(3) Momentarily hold the SIG EXT switch at SIG.	EXT lamp lights on C2296.	<u>No Light</u> (a) Report.
e. <u>C2299/VRC</u> (1) Turn squelch switches on Receiver, - Transmitters A1 and A2 to OFF. Turn RAD TRANS switch on C2299/VRC to 1.	Rushing noise is heard in Audio accessory. Connected to J703 or J704.	<u>No Noise</u> (a) Replace Audio Accessory. (b) Report.
(2) Turn Volume Control of C2299/VRC back and forth.	Loudness of noise increases and decreases smoothly.	<u>No Noise Variation</u> (a) Report.
(3) Have another radio set stand by to receive a signal for Receiver-Transmitter A1 on a given channel. Press the press-to-talk switch on the microphone connected to J703 or J704 and transmit a long voice test signal.	Operator at other radio set hears test signal loud and clear.	<u>No Signal Heard</u> (a) Change H161. (b) Report.
(4) Turn RAD TRANS switch to 2.	Rushing noise is heard in Audio accessory.	<u>No Noise</u> (a) Report.
(5) Have another radio set stand by to receive a signal from Receiver-Transmitter A2 on a given channel. Press the press-to-talk on microphone connected to J703 or J704 and transmit a long voice test signal.	Operator at other radio set receiver hears test loud and clear.	<u>No Voice</u> (a) Report.
(6) Tune Receiver-Transmitters A1 and A2 to different channels. Have an operator at a distant receiver-transmitter tune to the A1 channel & an operator at a second receiver-transmitter tune to the A2 channel.	Operator at two distant stations communicate with each other and both stations are heard at the C2299/VRC.	<u>No Voice</u> (a) Check frequency spacing. (b) Check SQUELCH settings. (c) Check C-2299.

RESTRICTED

4 - 25/. of Receiver

RESTRICTED

4 - 25

Test	Result	Action
Turn squelch switches of Receiver-Transmitters A1 and A2 to ON.  Arrange for communications to begin after a short time interval. During the interval, turn RETRANS switch to ON.		(d) Report.
(7) Turn Retrans switch OFF.	None.	None.

Note:

If the C2299/VRC is connected to the Radio Set through the AM/1780-VRC no audio signal will be heard through the audio accessories at connectors J703 and J704.

Note:

Sub para 1-5 concerns when it is connected directly to the A and C set mounting trays and NOT to the AM/1780-VRC.

Closing Down Drill

118. The Closing Down Drill for the AN/VIC 1 (V) harness is as follows:-

- a. Turn the power circuit breaker switch to OFF.
- b. Turn the main power switch to OFF.
- c. Remove and stow all audio equipment (if closing down for long periods).
- d. Check security and condition of all components and leads.
- e. Check condition and security of all switches and controls.
- f. Clean and dry all equipment.
- g. Report/replace any defective equipment.

4 - 26/. (illus)

RESTRICTED



RESTRICTED

4 -

HARNESS POWERED DIRECT

CONTROL (3 ONLY)

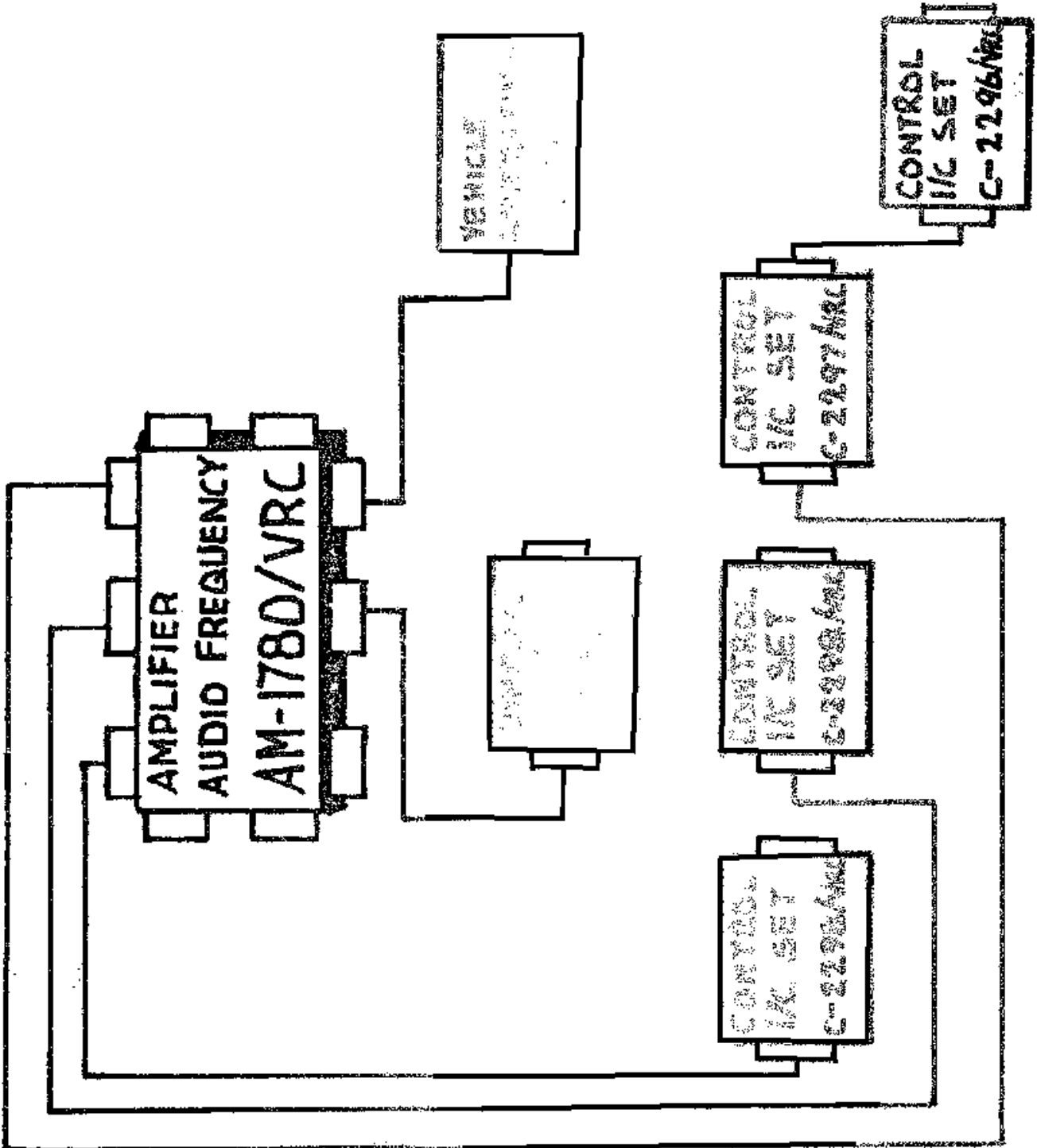

Figure 47

RESTRICTED

4 - (illus)

RESTRICTED

4 - 27

TYPICAL AN/VIC 1 (V) HARNESS CONFIGURATION

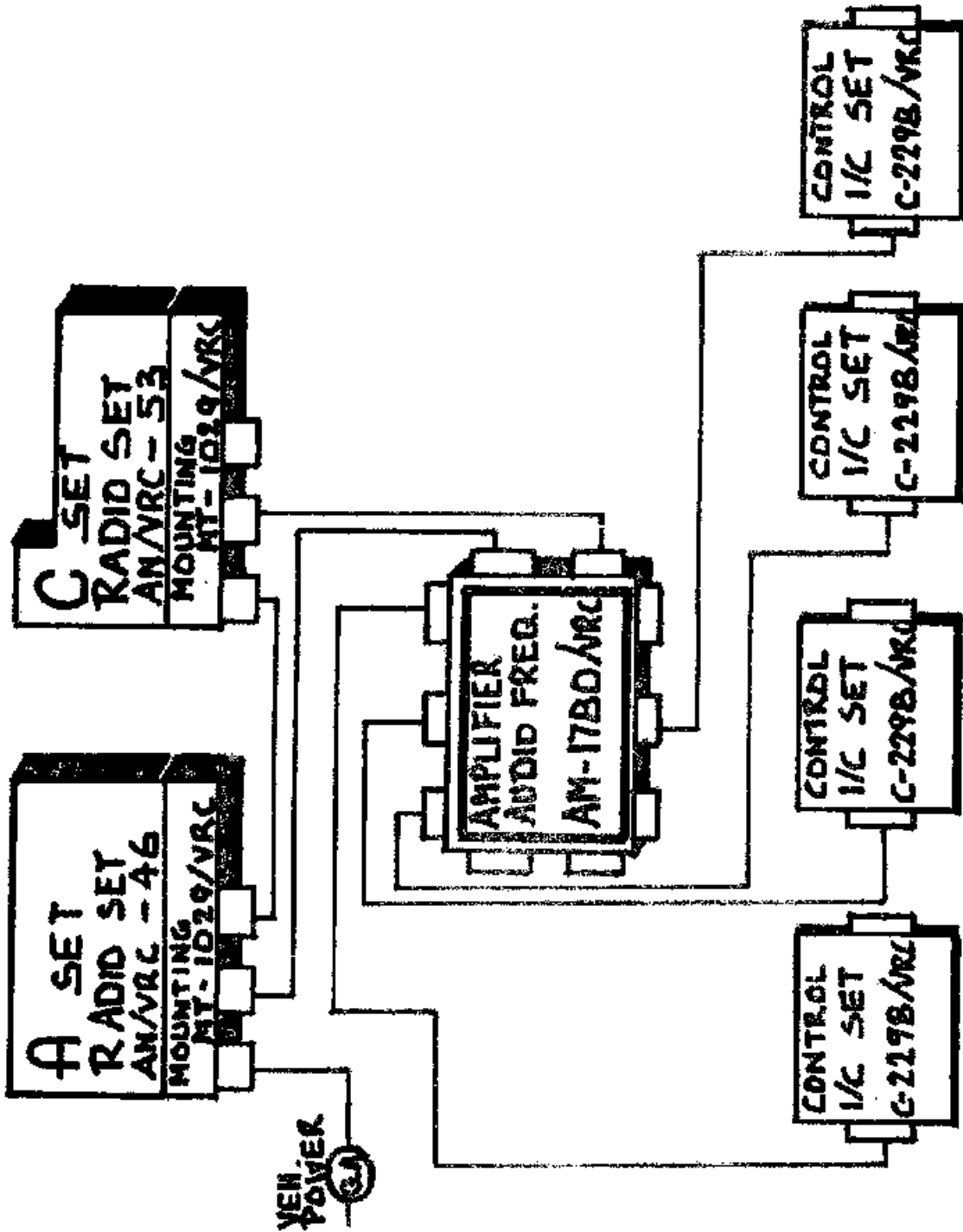

Figure 48

RESTRICTED

4 - 28/. (illus)

RESTRICTED

COMPLETE AN/PAC (V) HARNESS

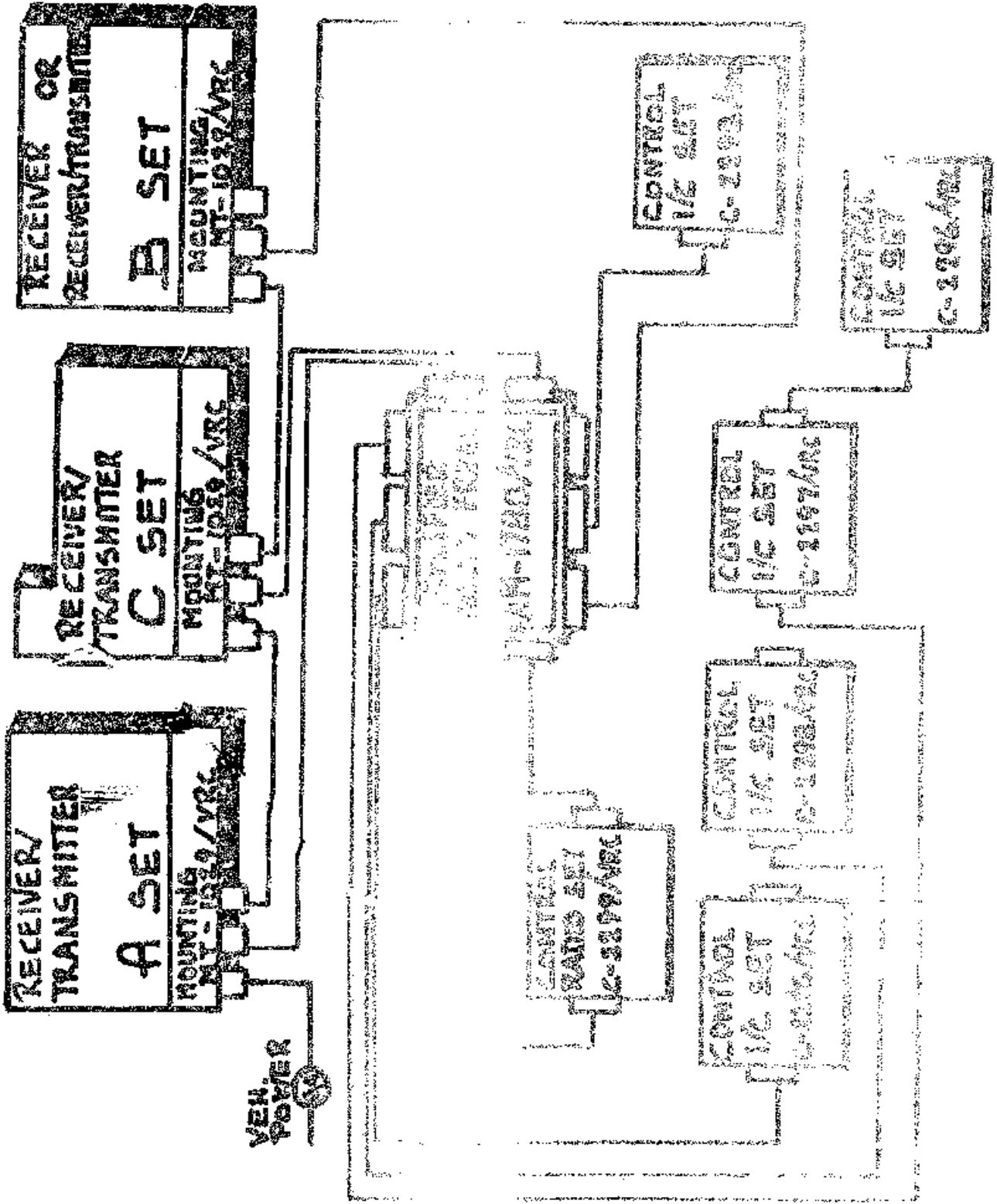

Figure 47

RESTRICTED